

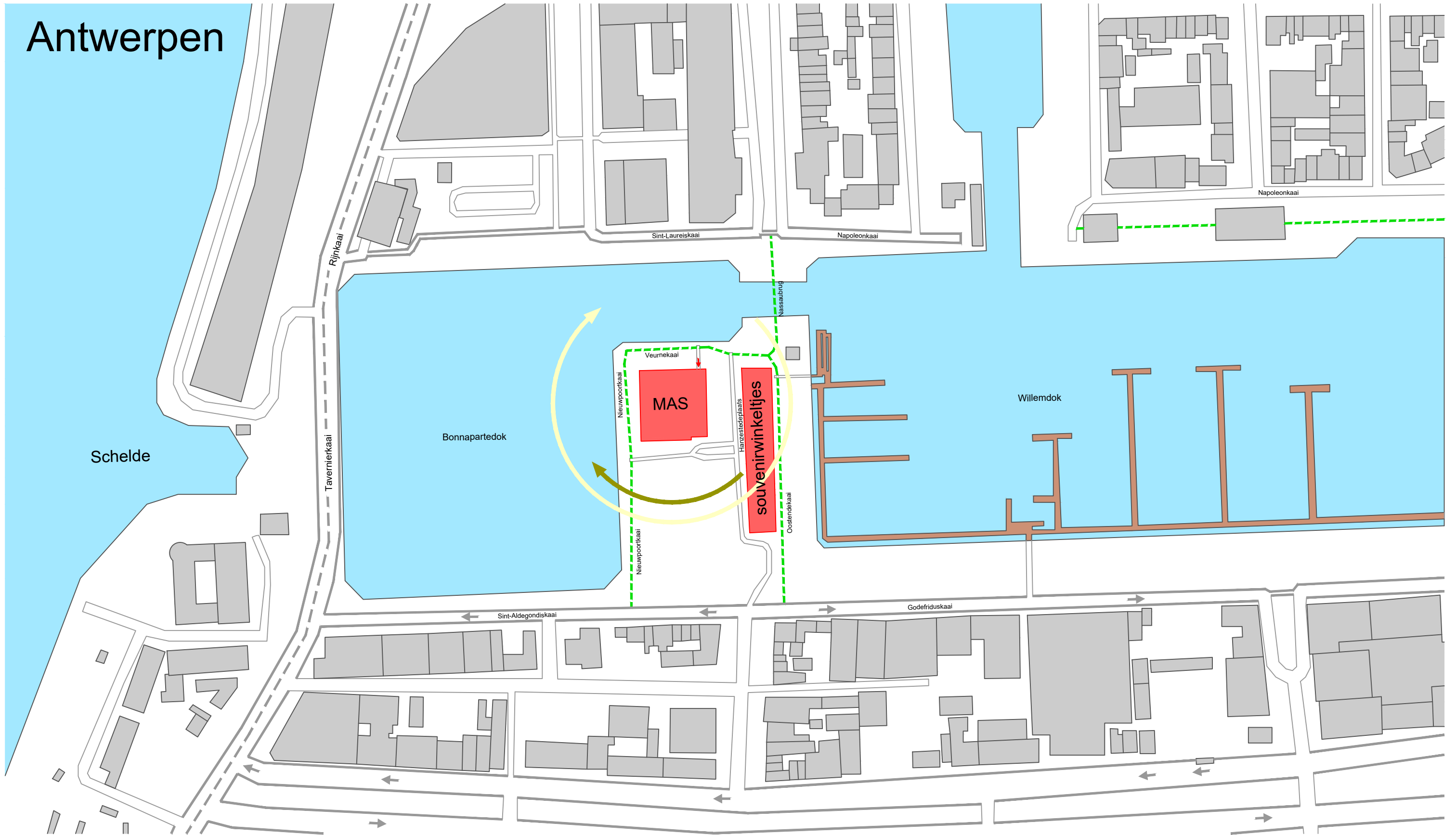





Antwerpen



- | | | | |
|---|---|---|--|
|  Zon in de zomer |  Gebouwen |  Wegen |  Water |
|  Zon in de winter |  Fiets- en wandelpad |  Aanlegsteiger |  Museum aan de stroom (MAS) |

Omgevingsanalyse

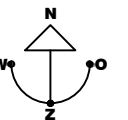

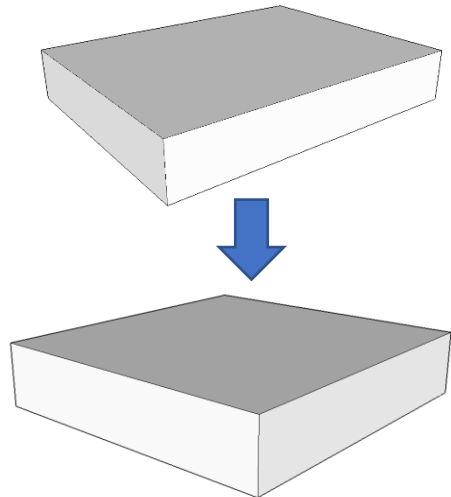

Bovenop plaatsen

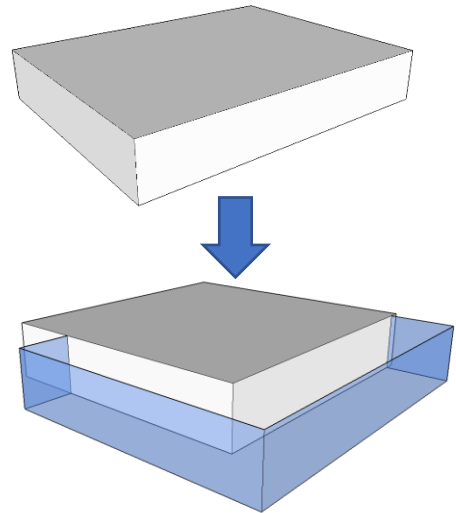

Bovenop plaatsen

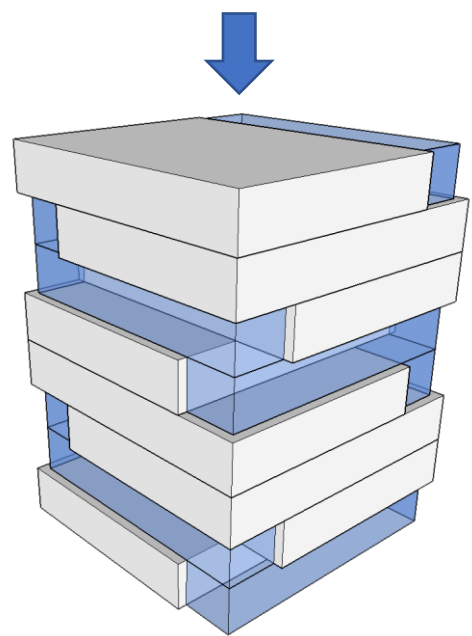
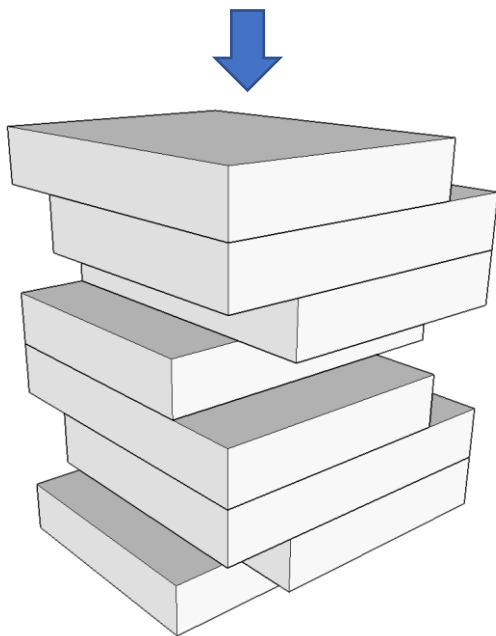

Op elkaar stapelen + kwartdraai

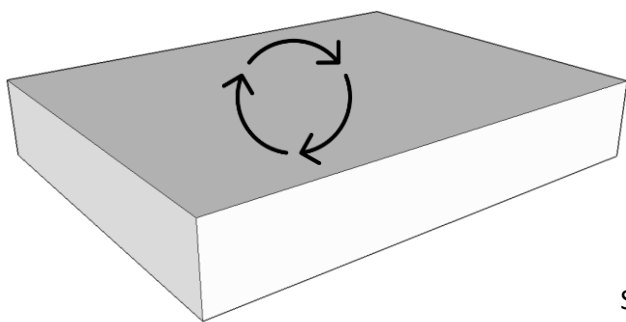

8X

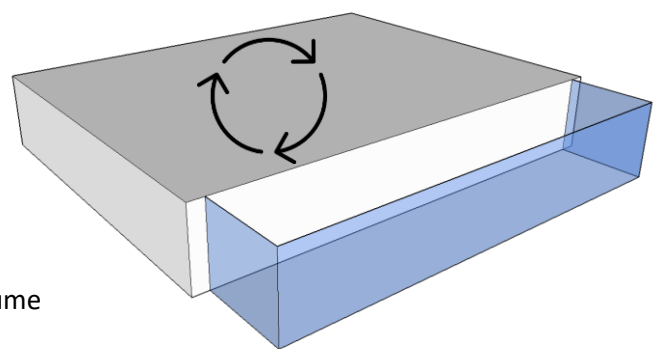

Startvolume

Resultaat

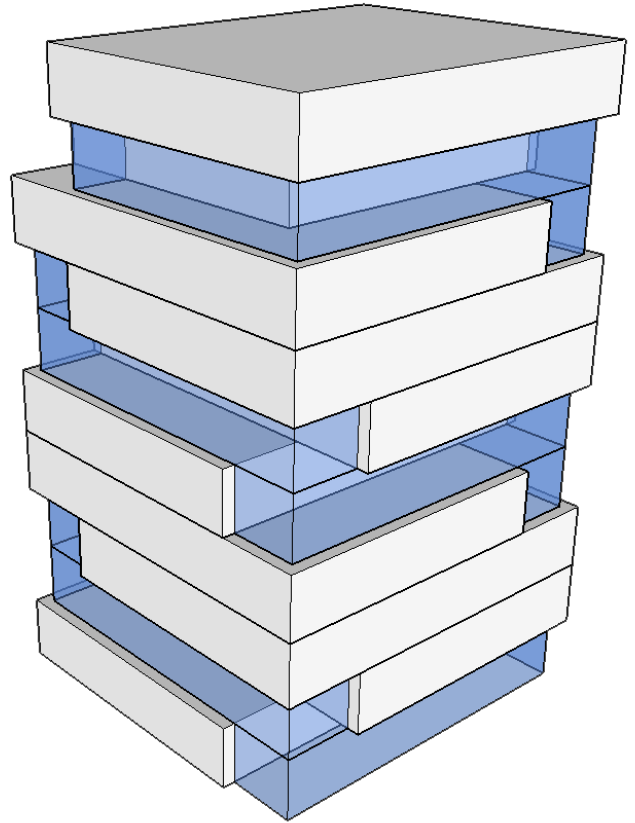
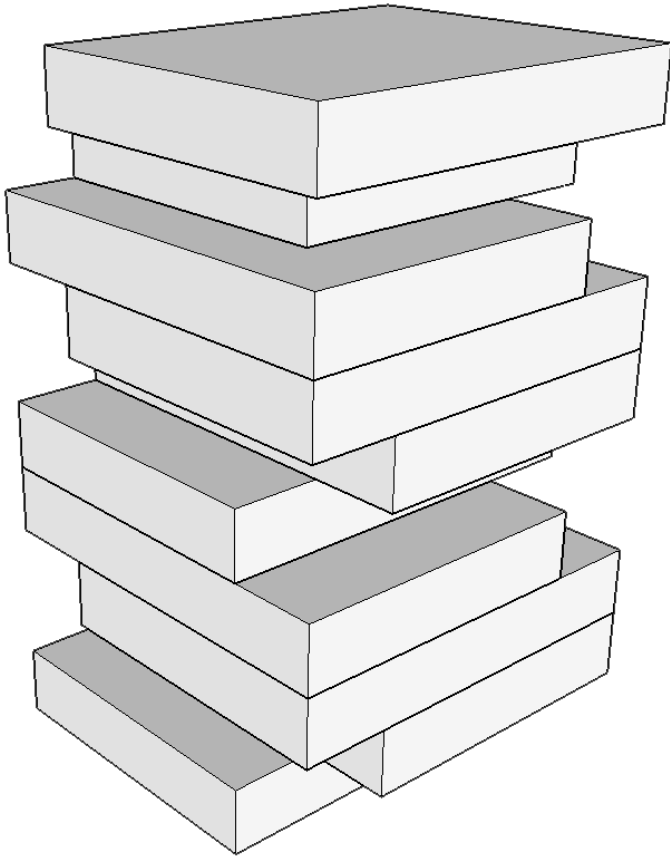
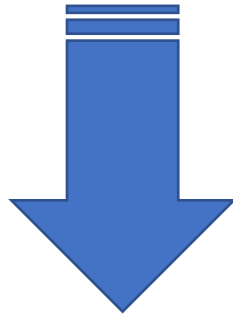

Organogram

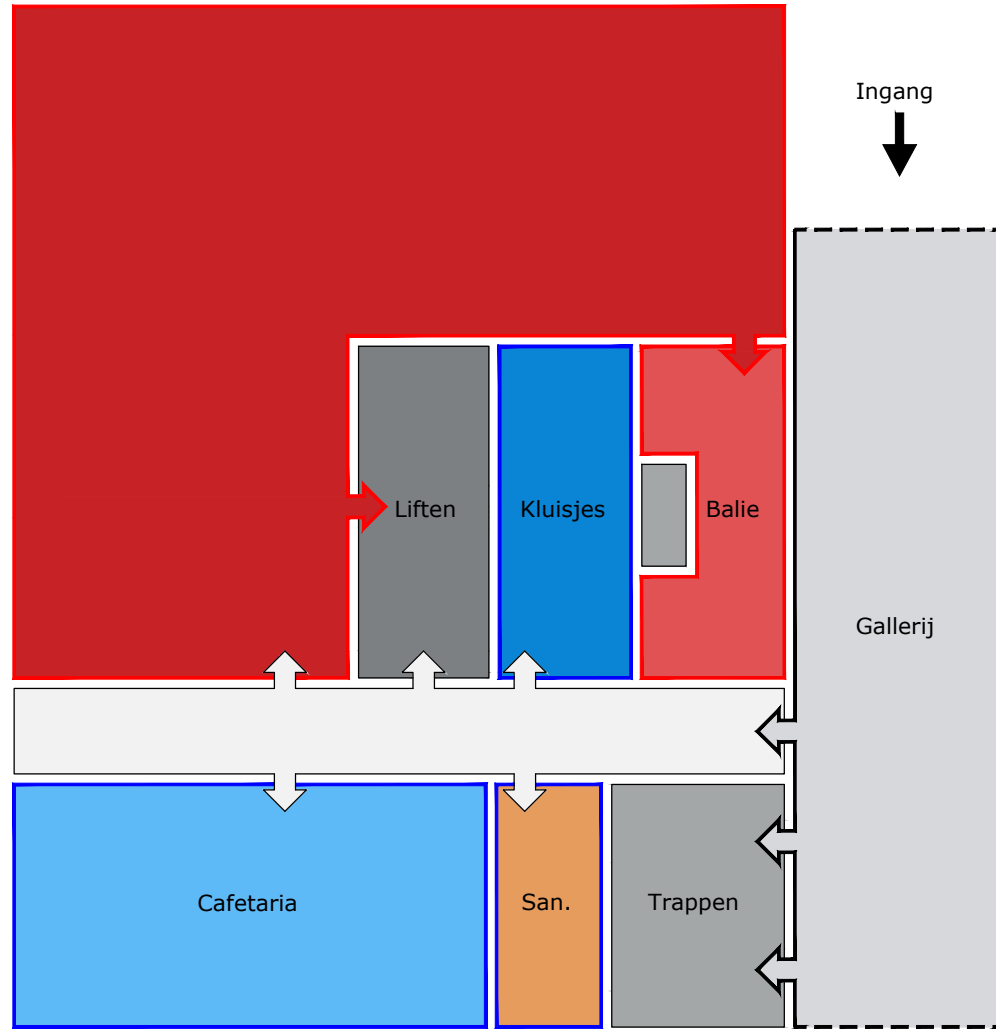

Level 0

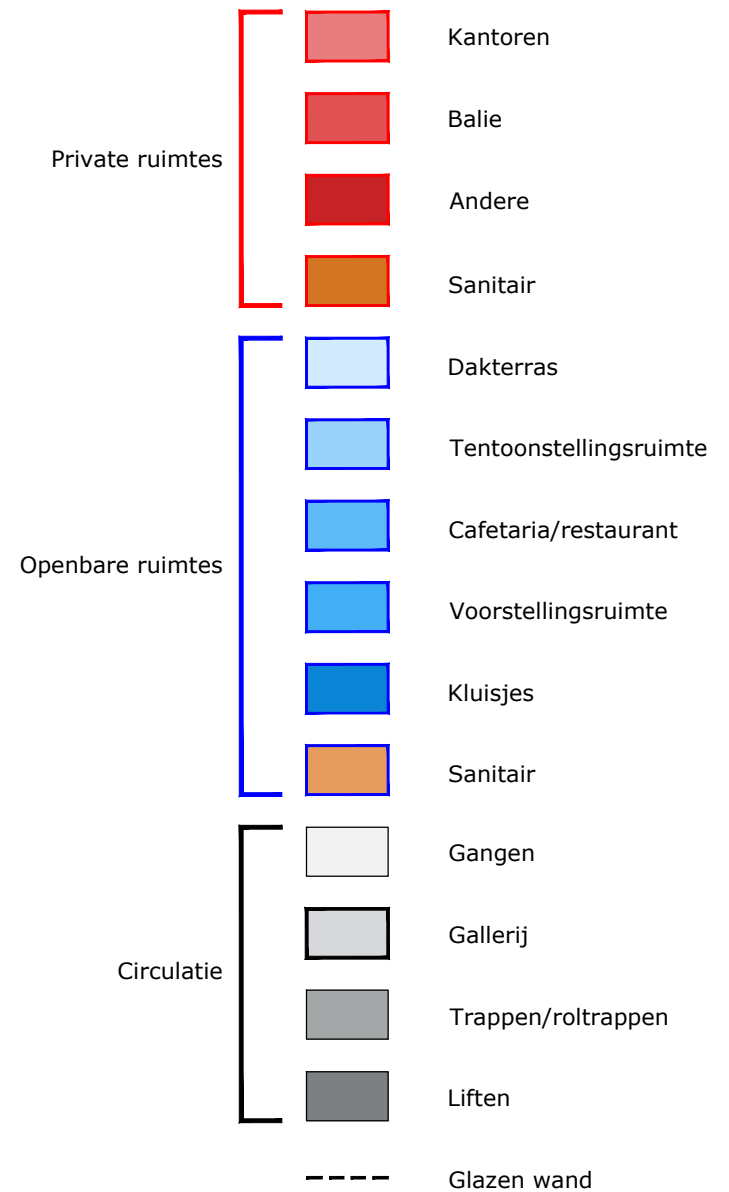

Organogram

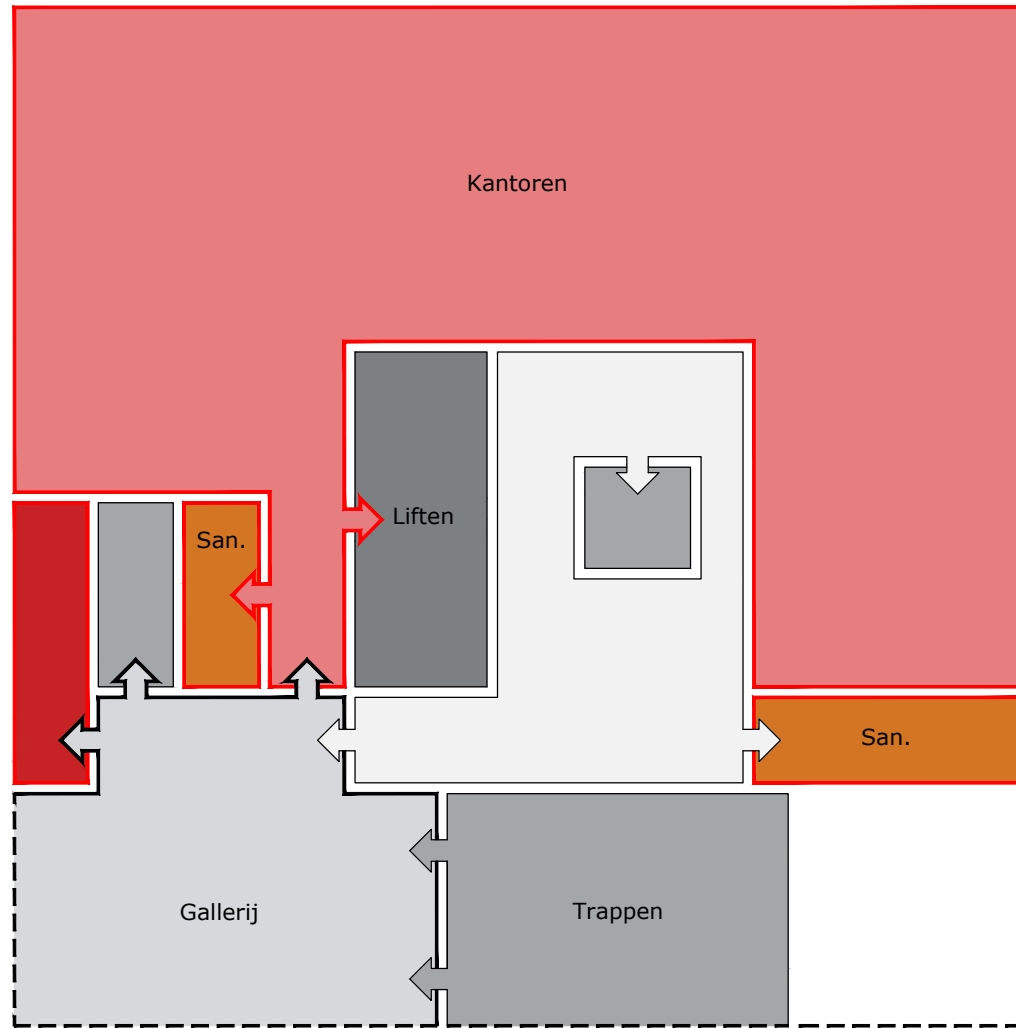

Level 1

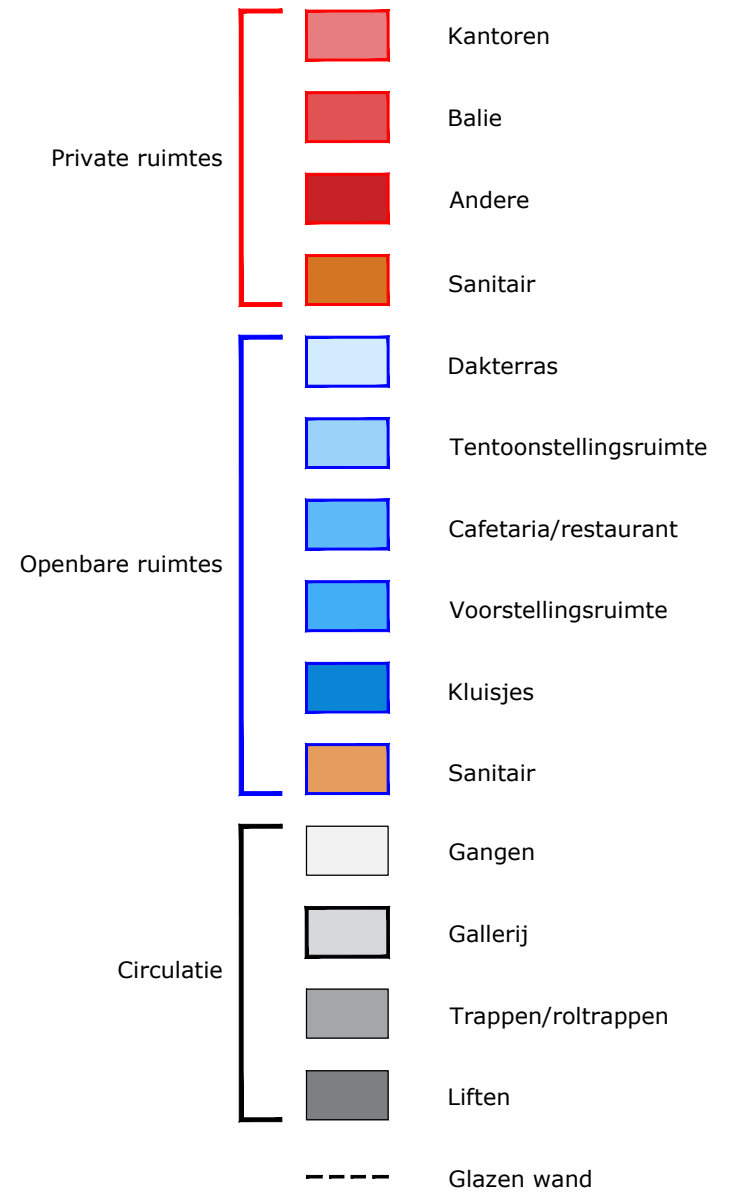

Organogram

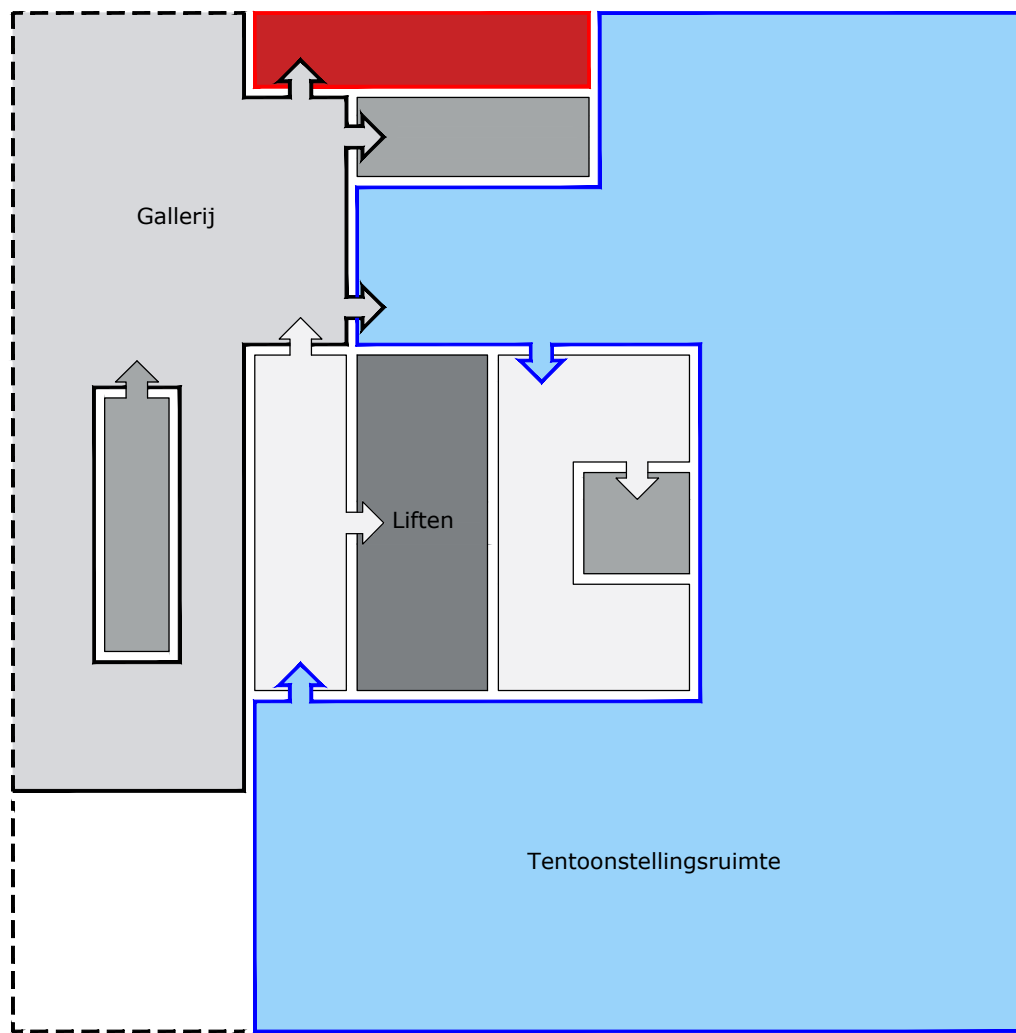

Level 2

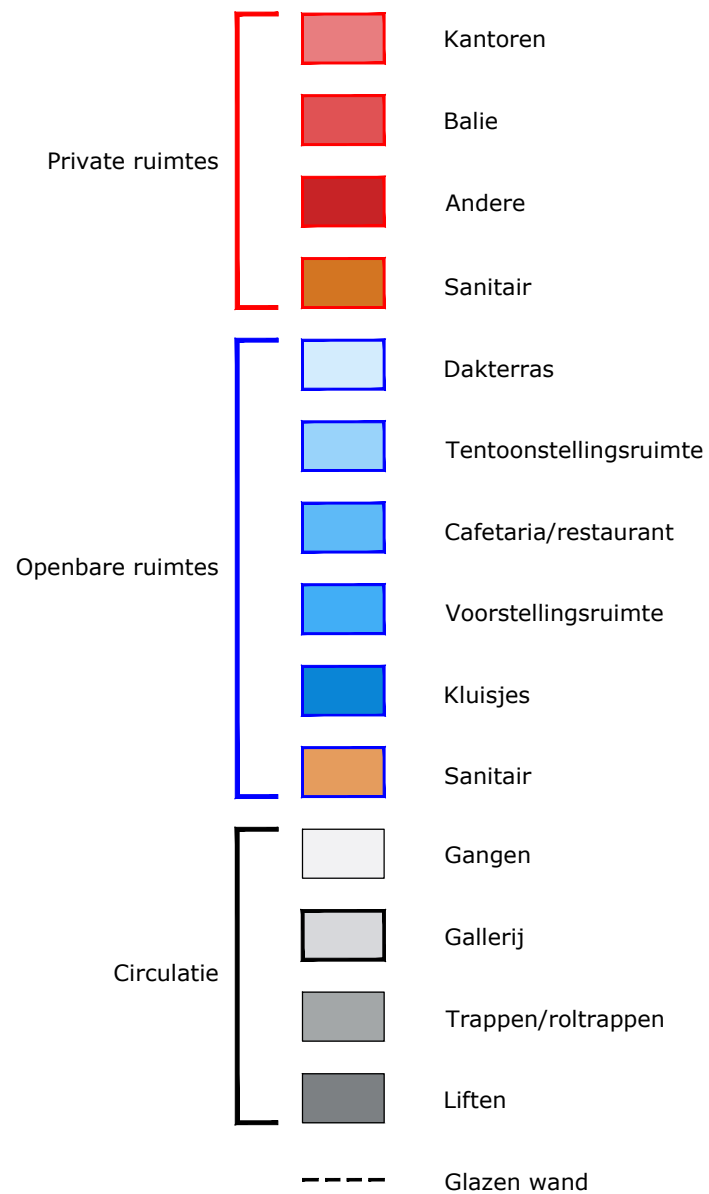

Organogram

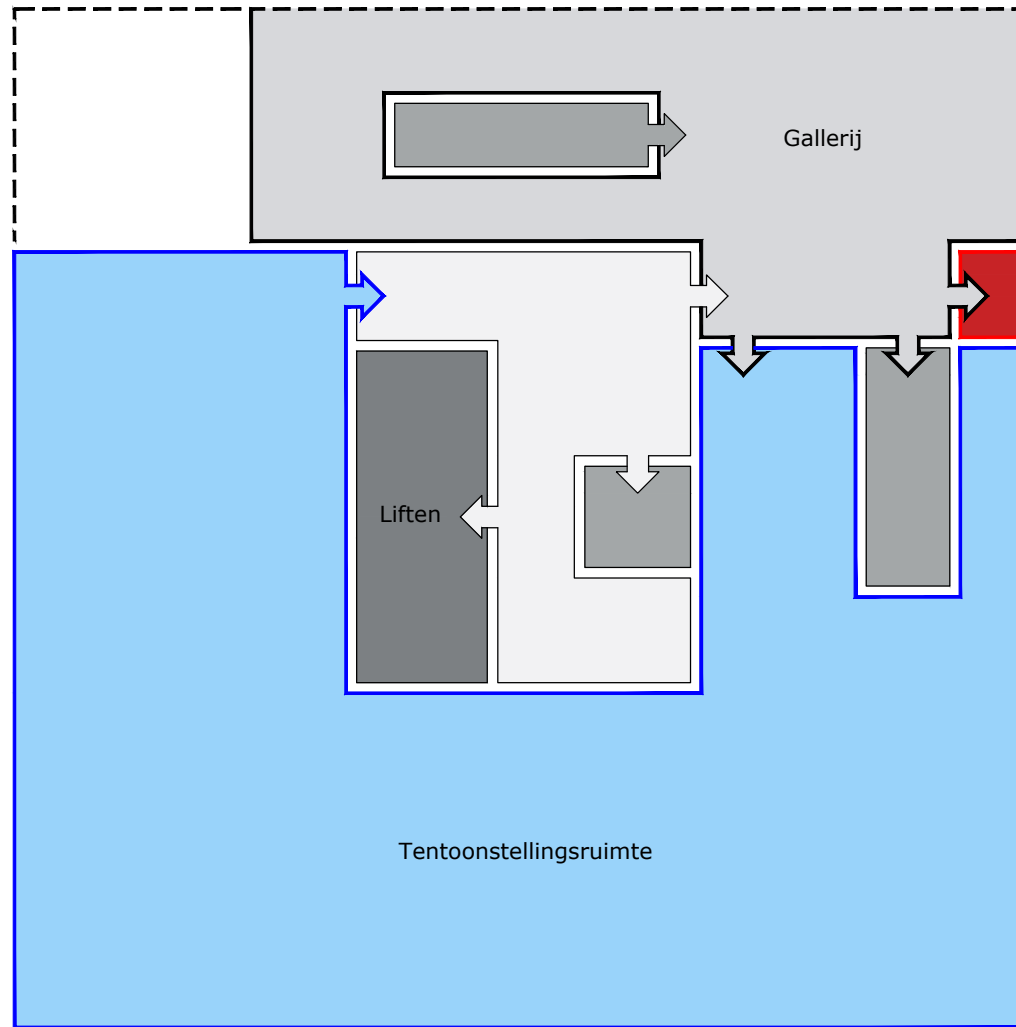

Level 3

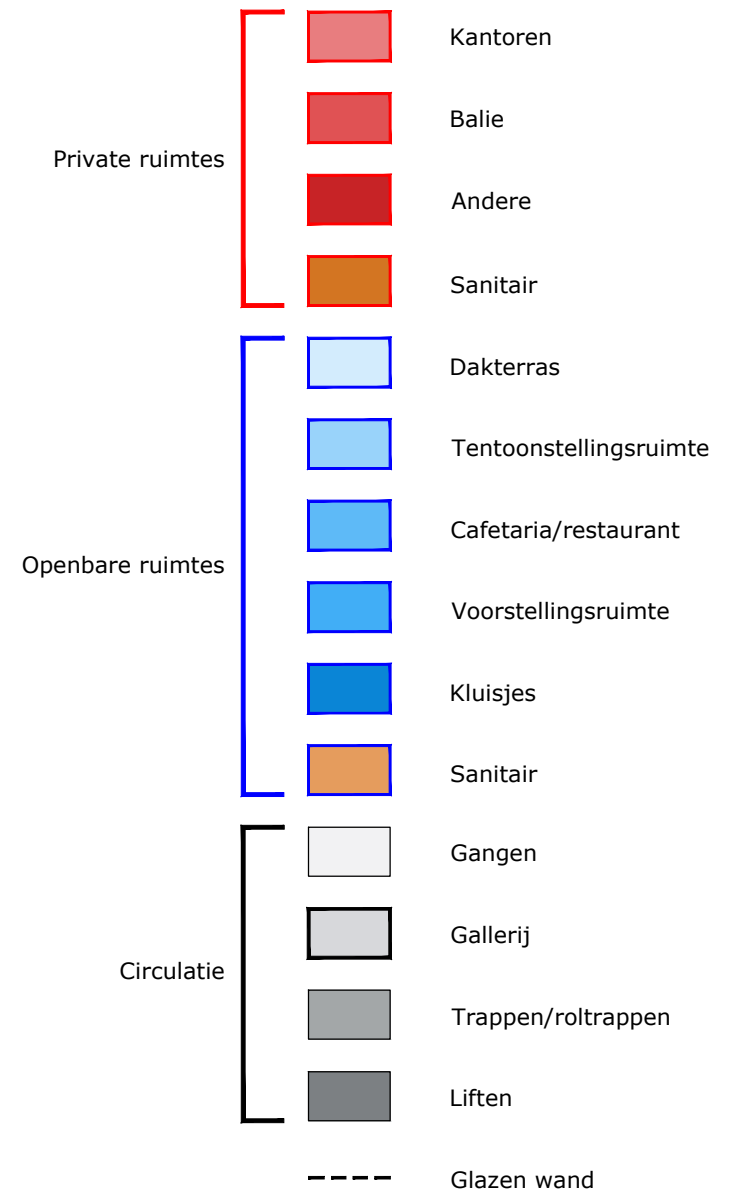

Organogram

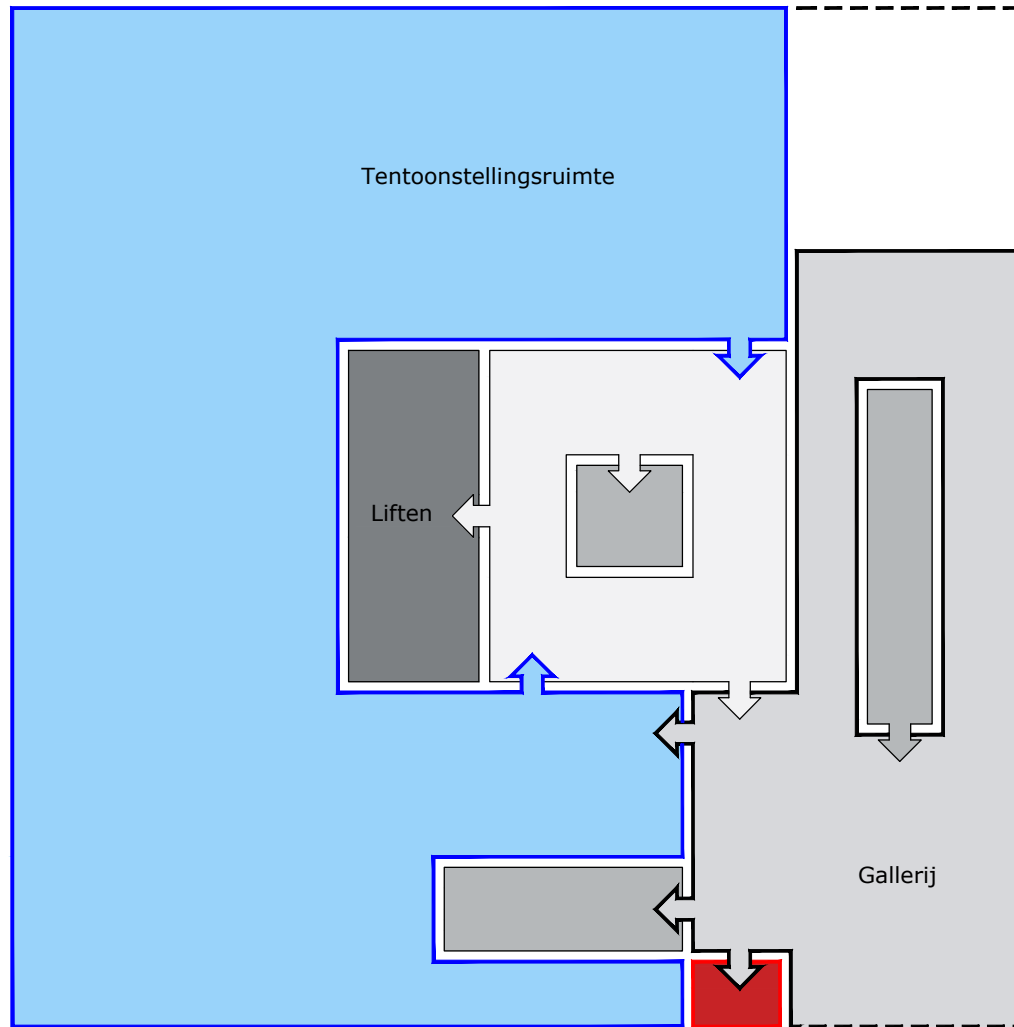

Level 4

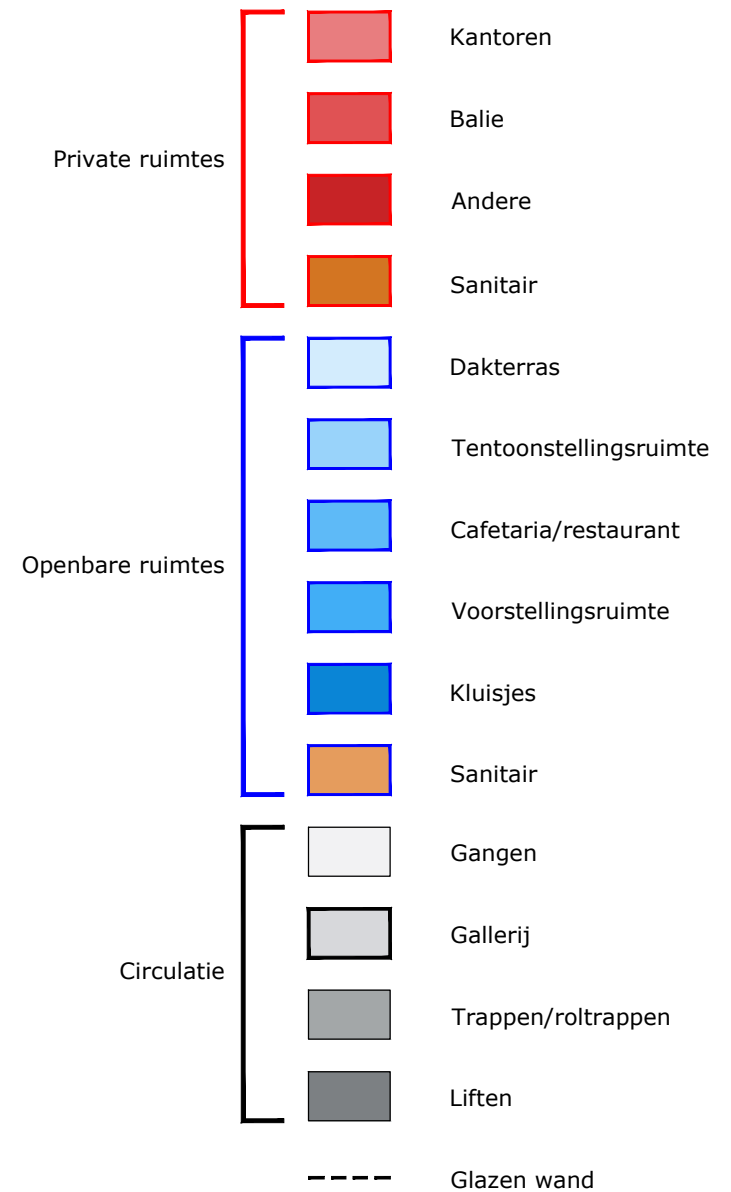

Organogram

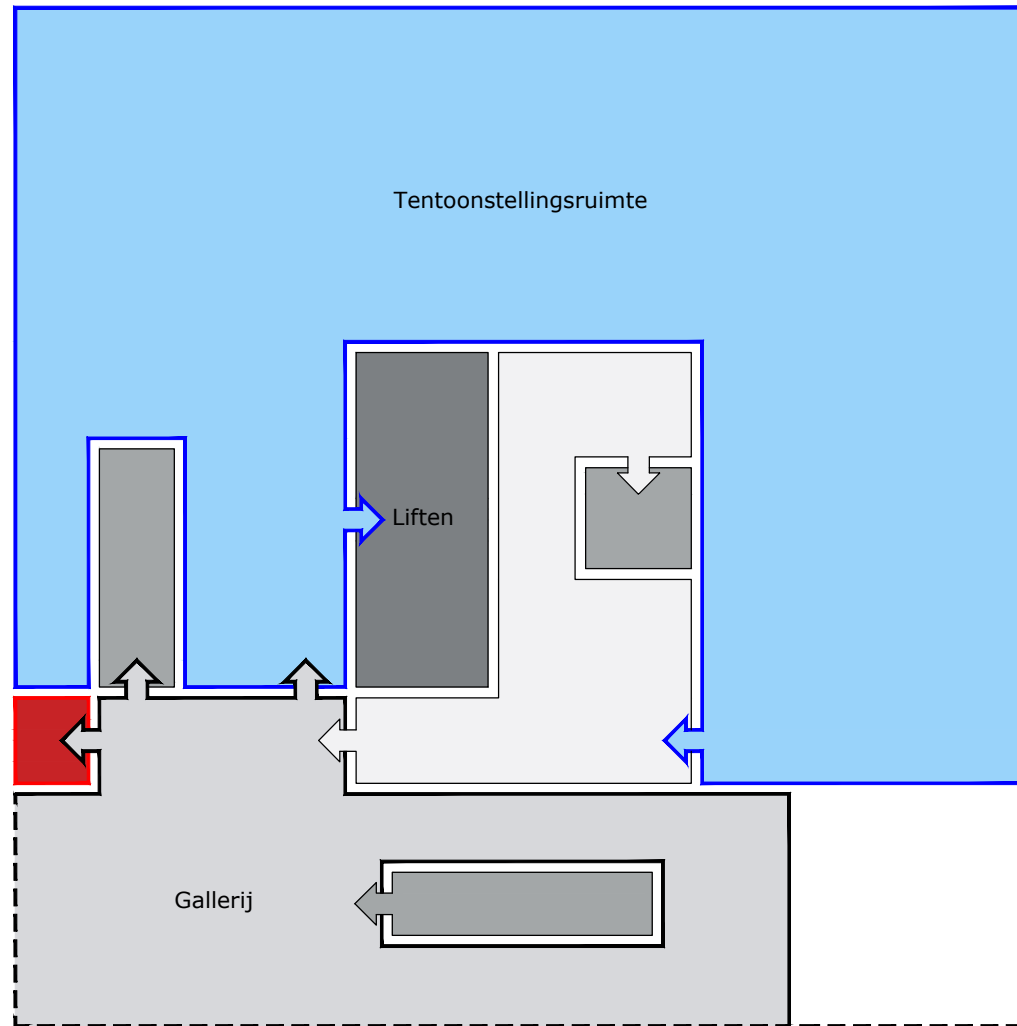

Level 5

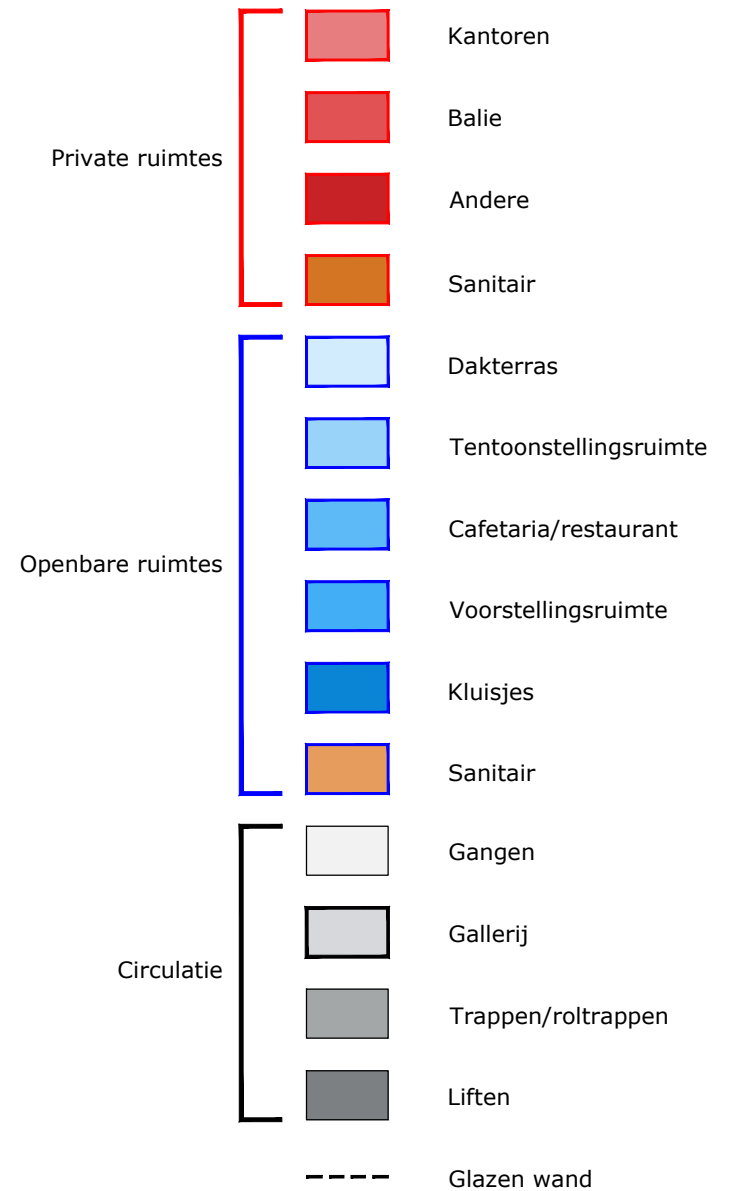

Organogram

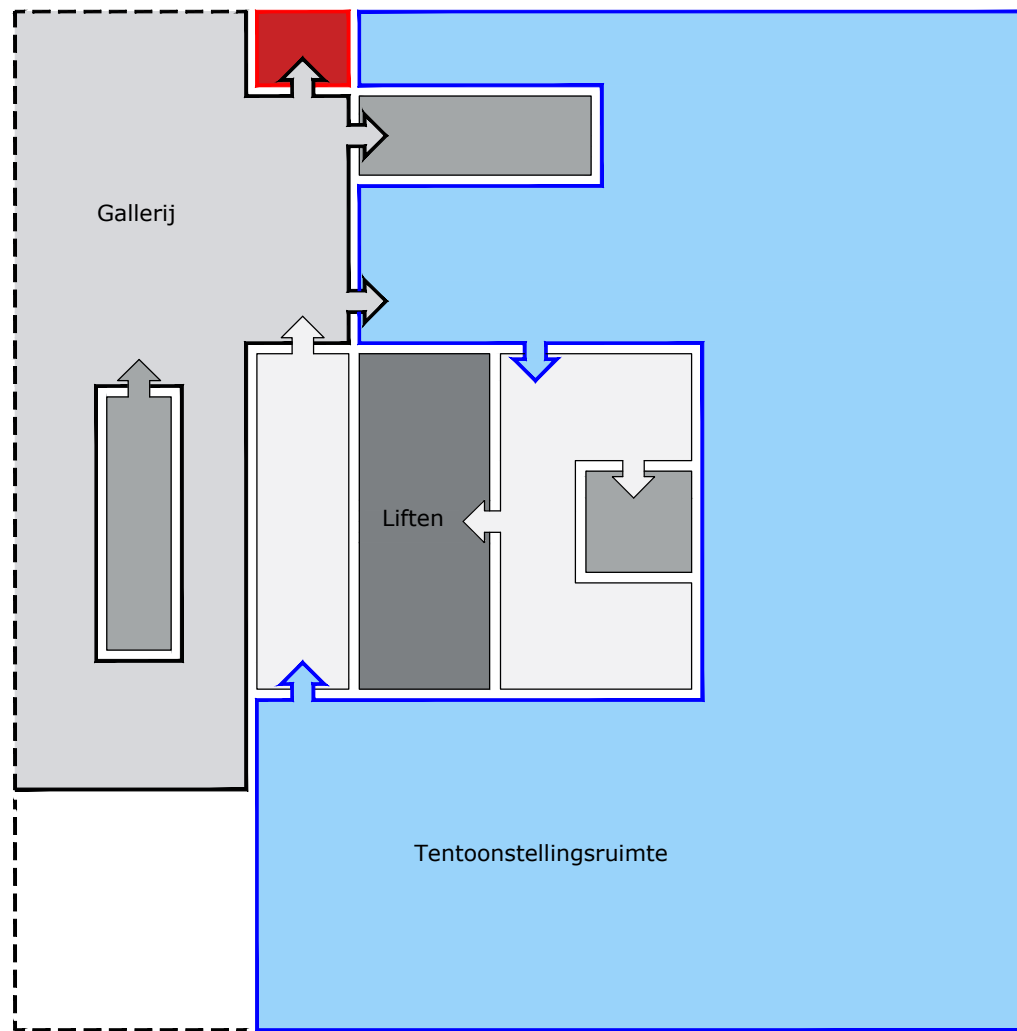

Level 6

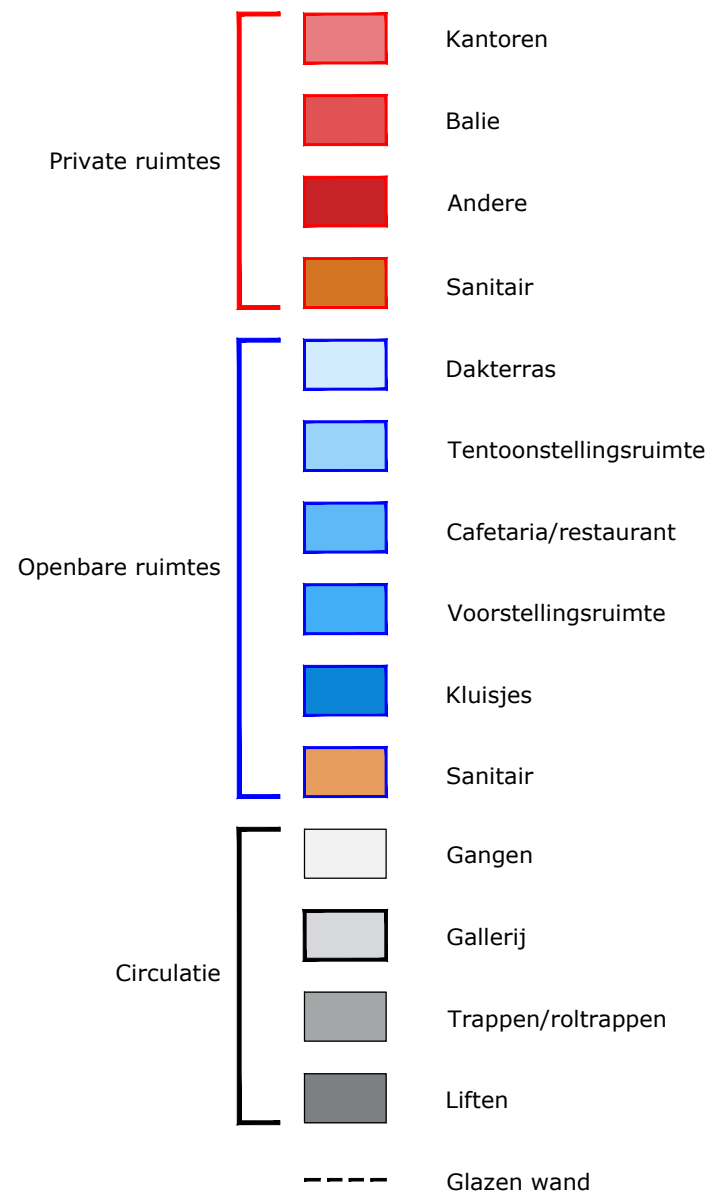

Organogram

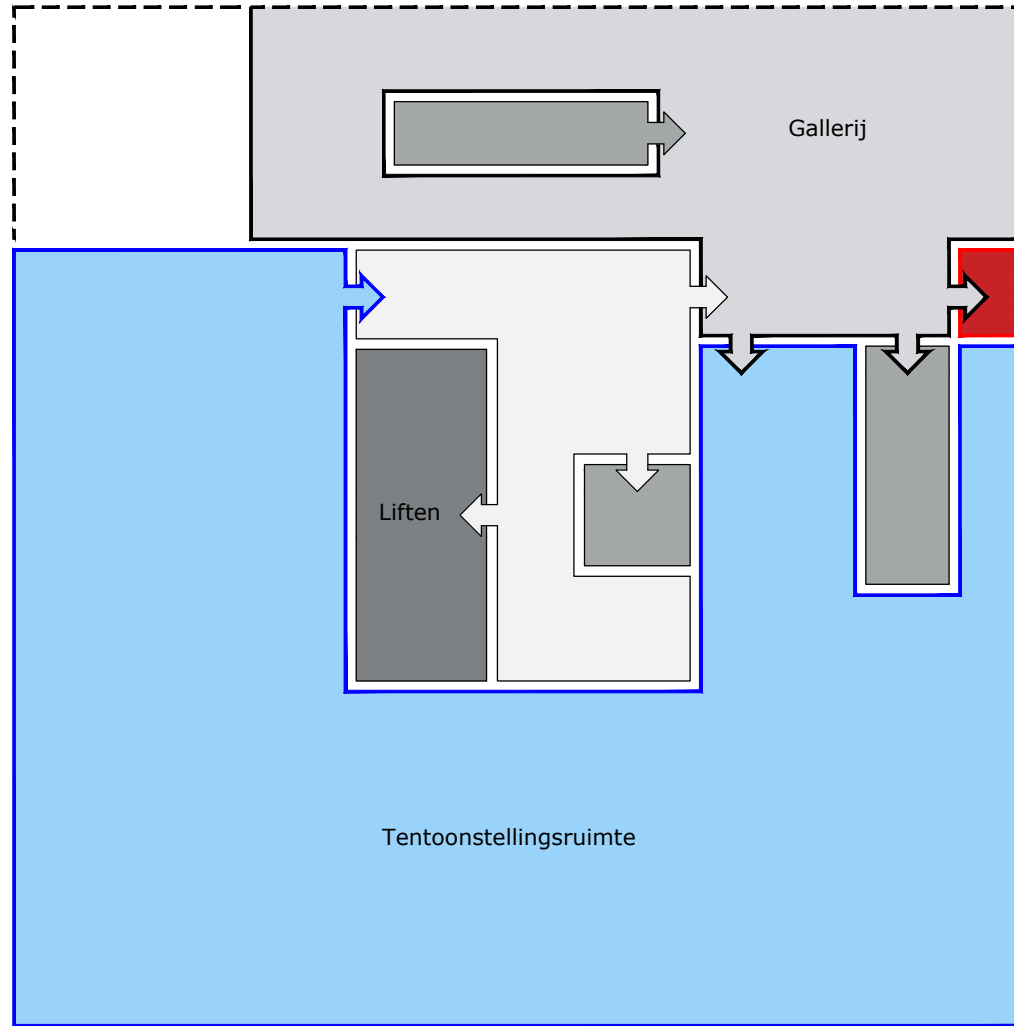

Level 7

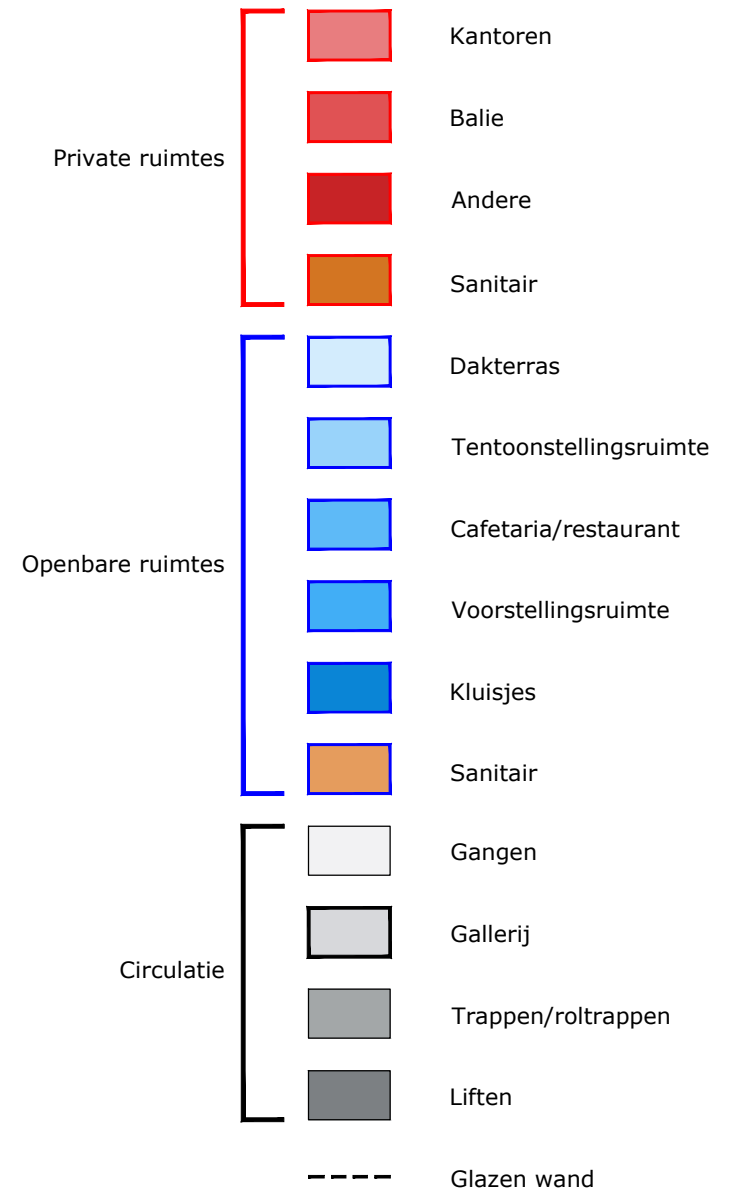

Organogram

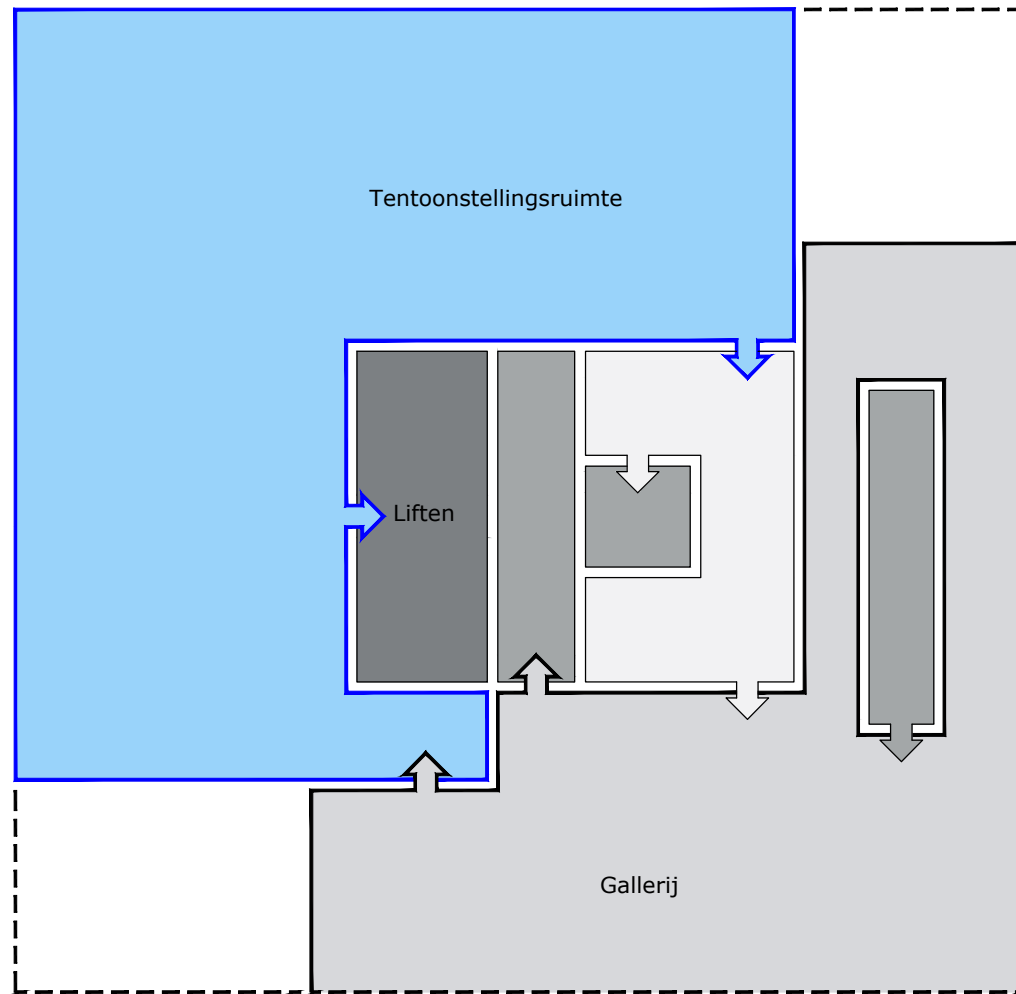

Level 8

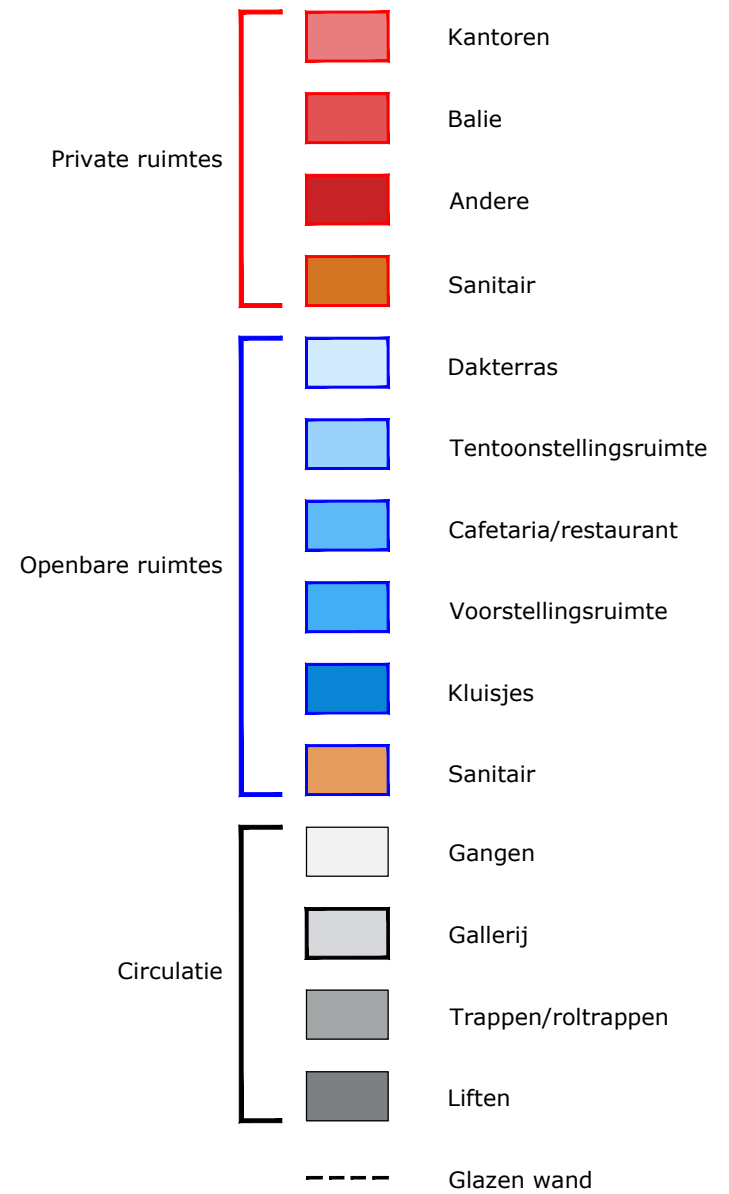

Organogram

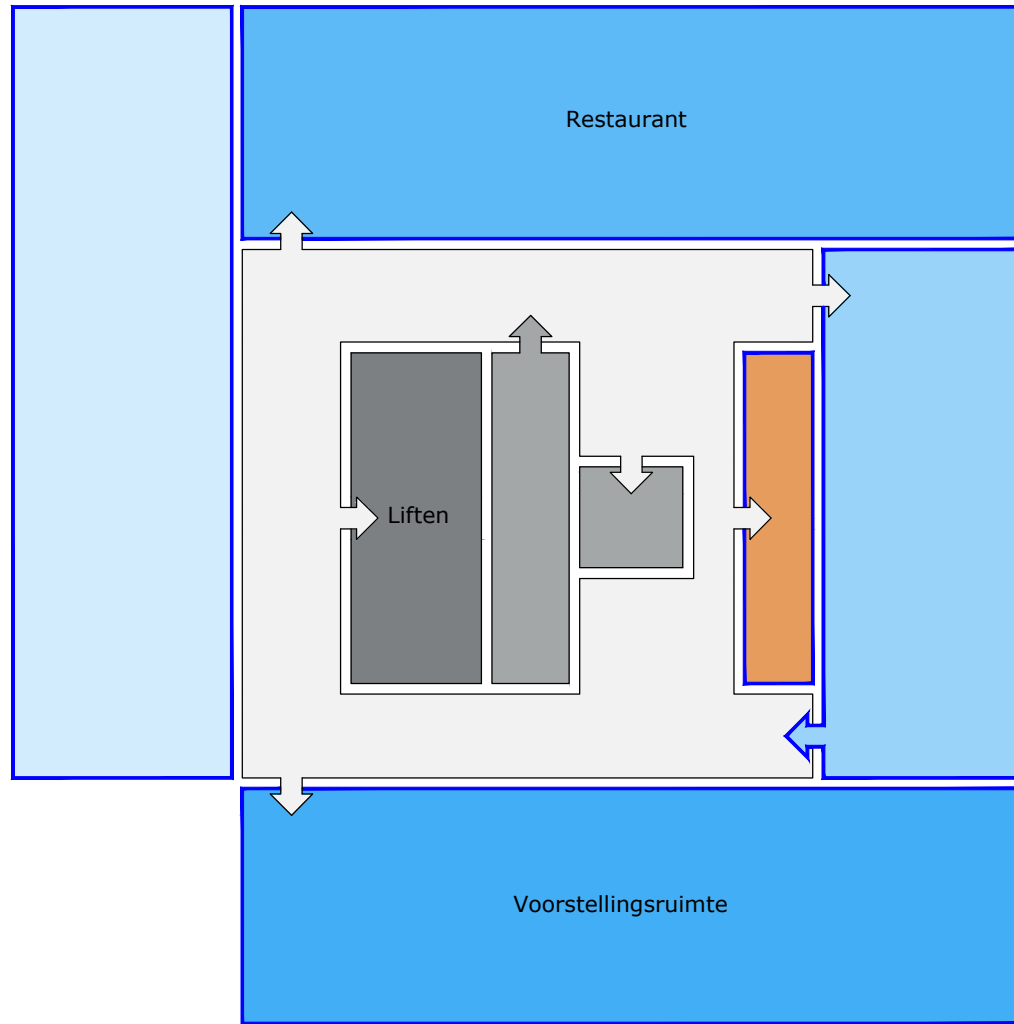

Level 9

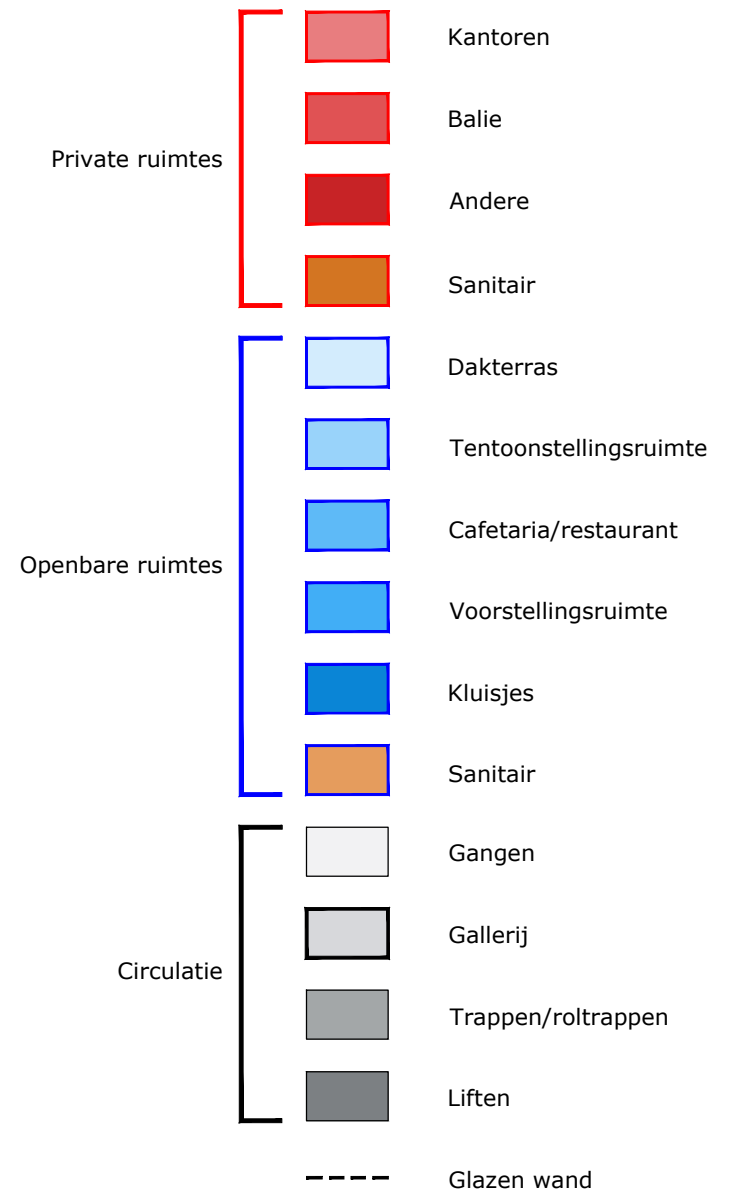

Plananalyse

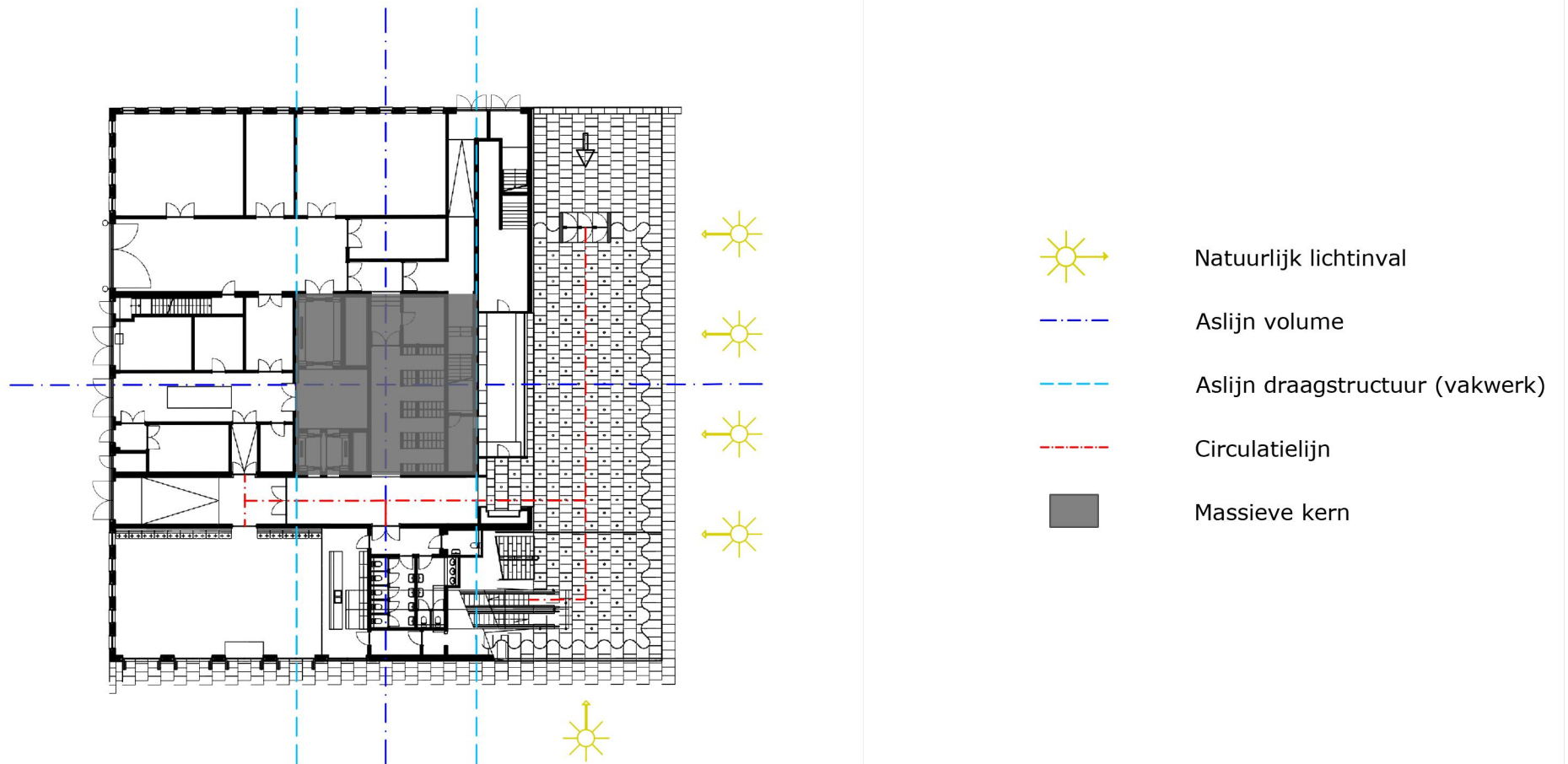

level 00

Plananalyse

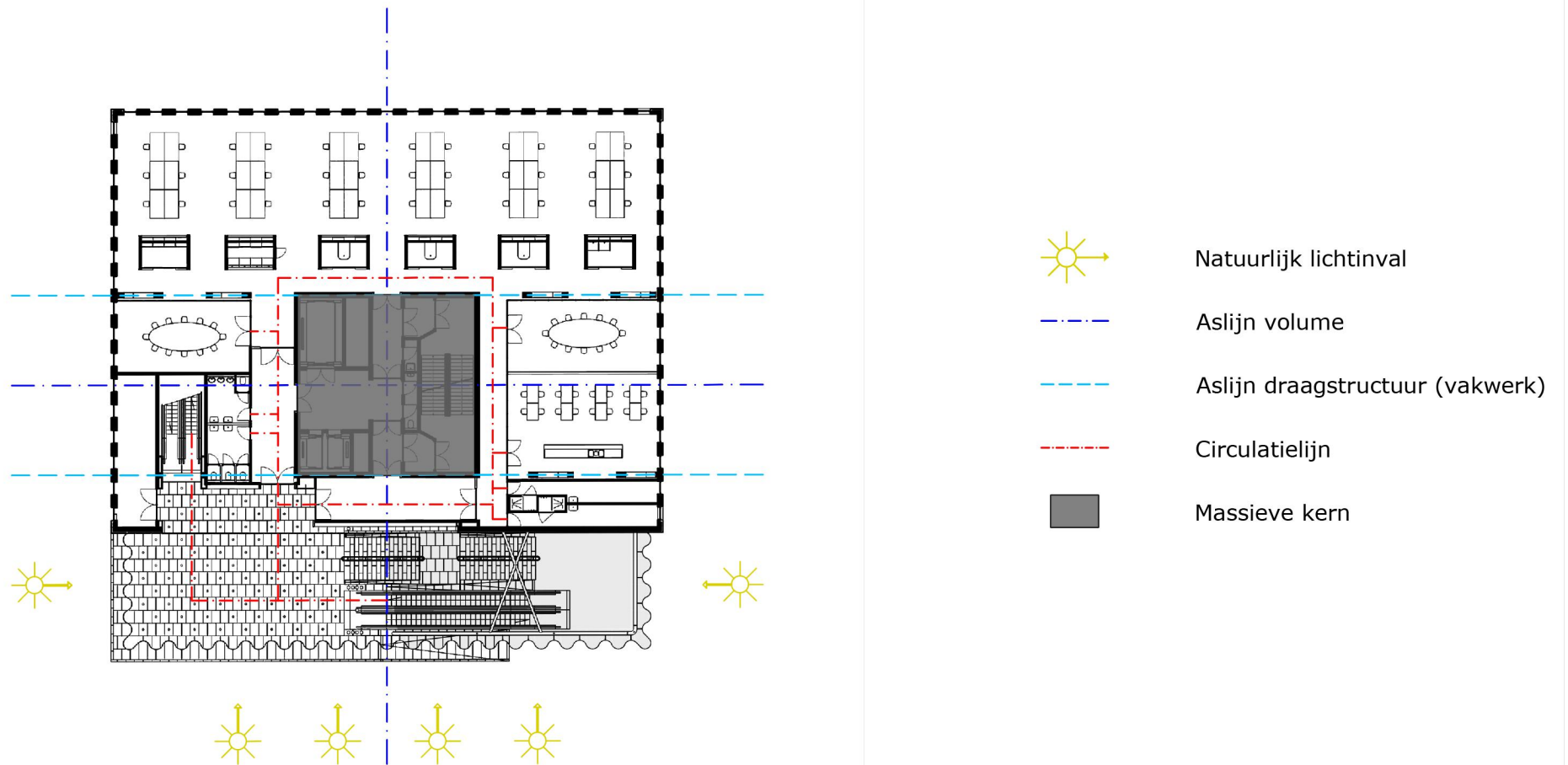

level 01

Plananalyse

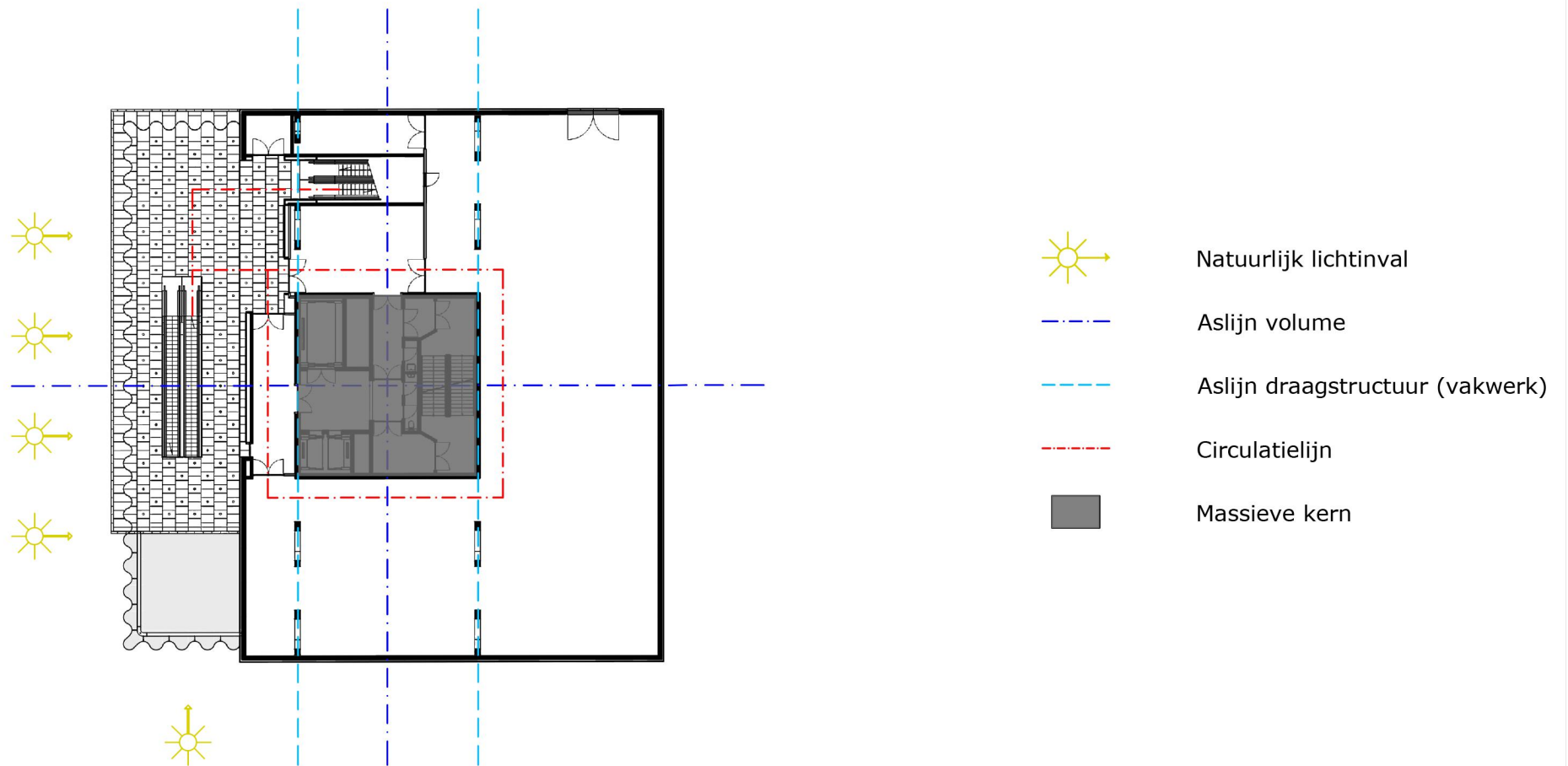

level 02

Plananalyse

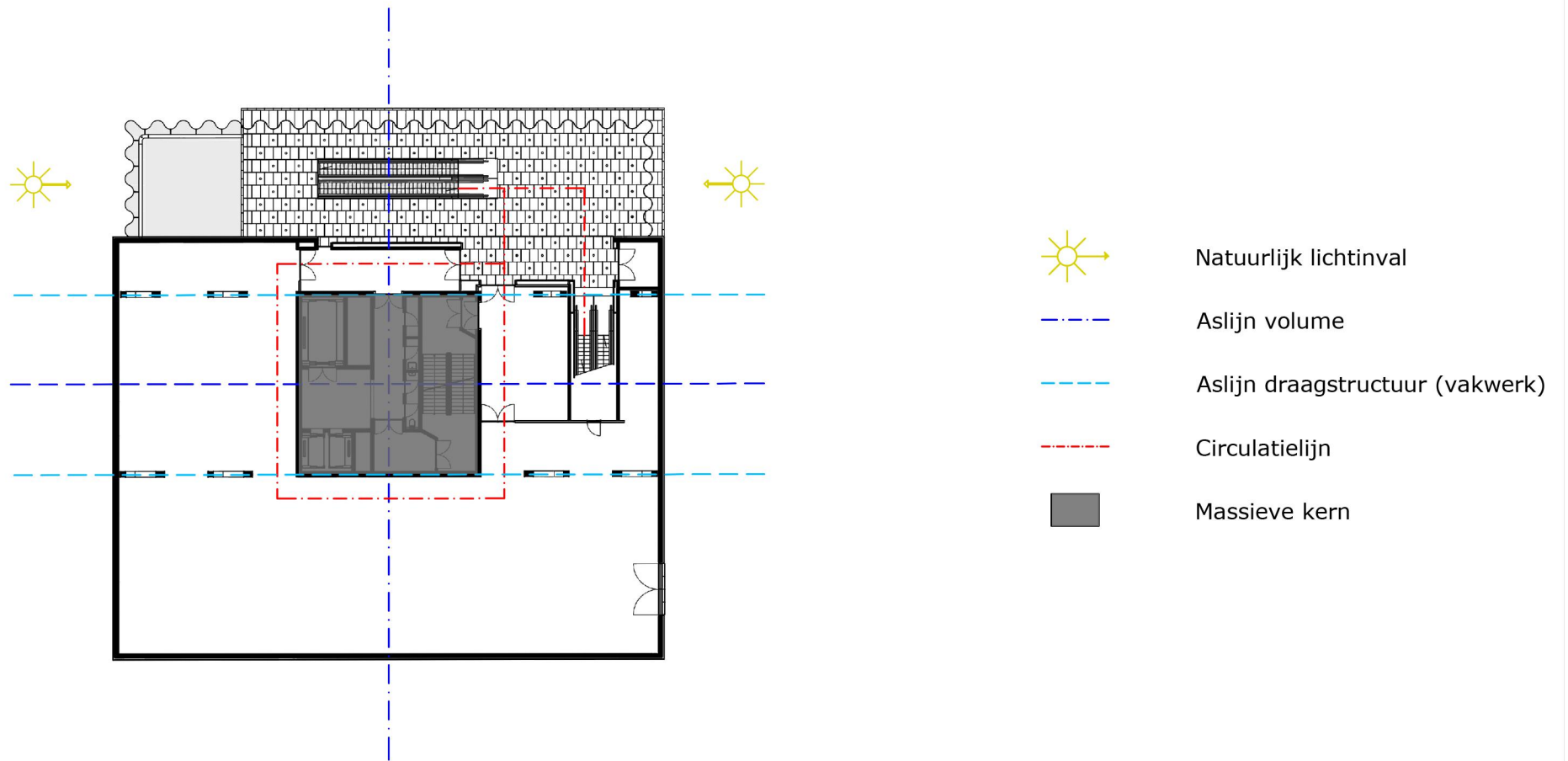

level 03

Plananalyse

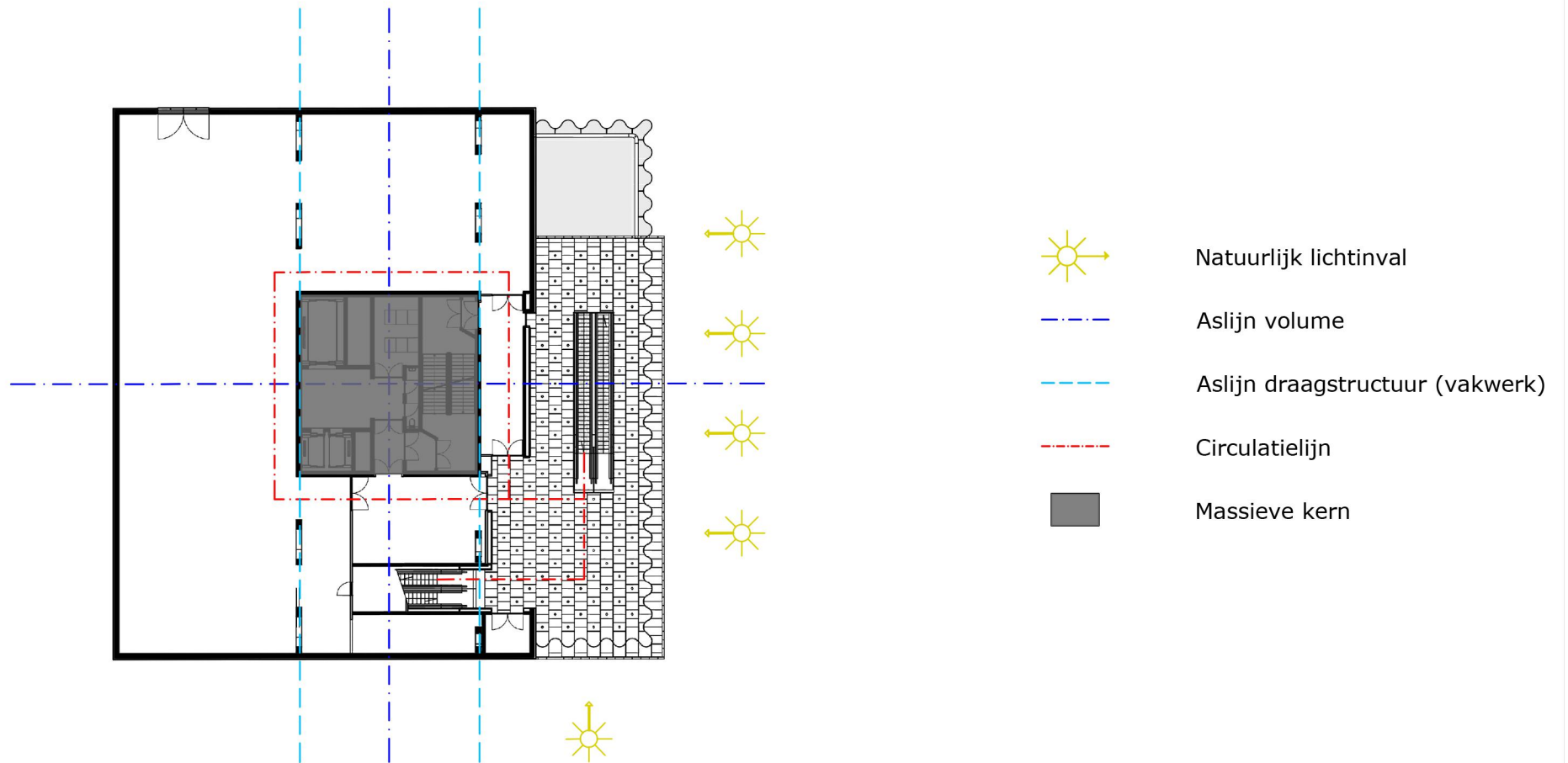

level 04

Plananalyse

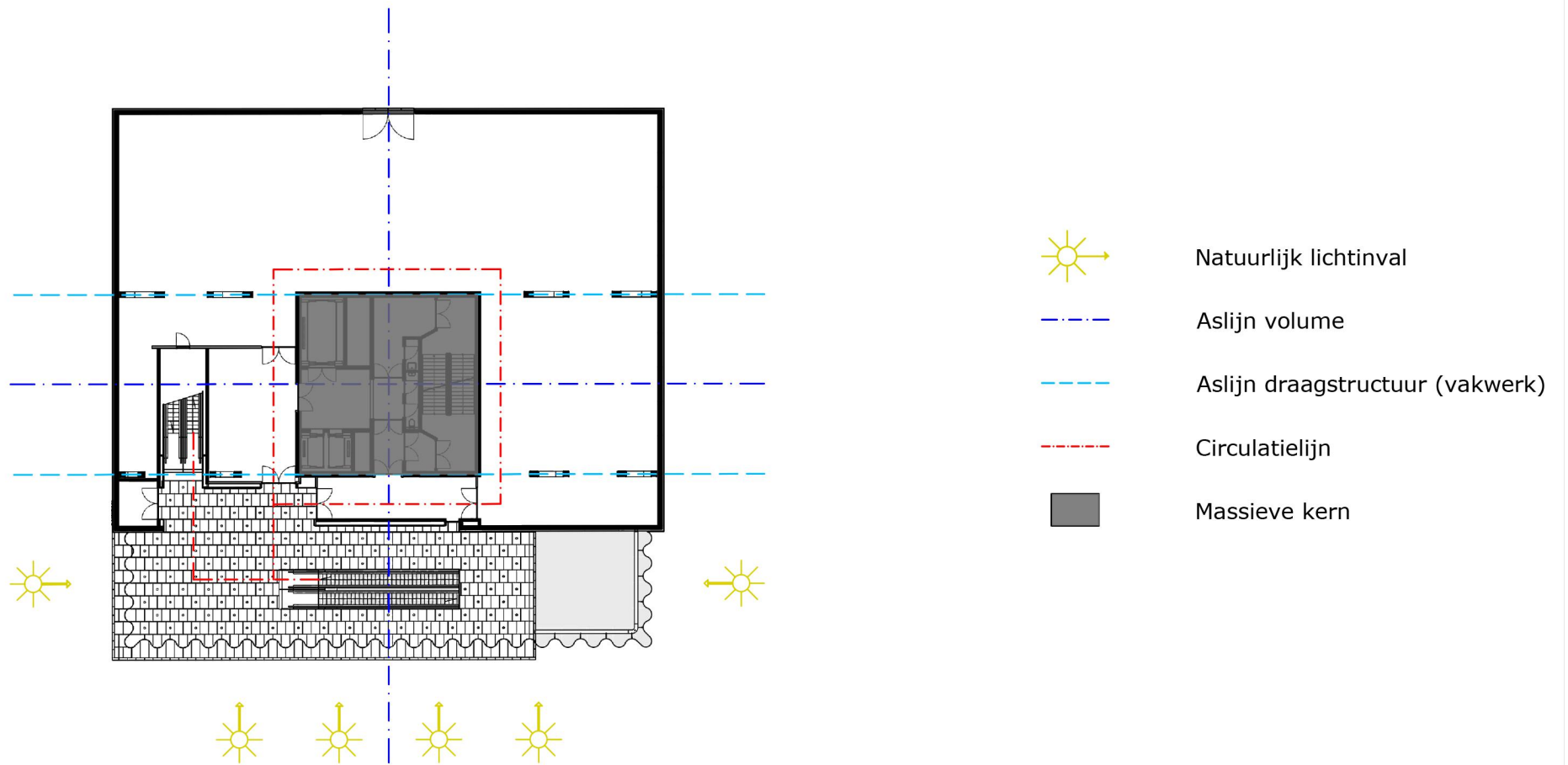

level 05

Plananalyse

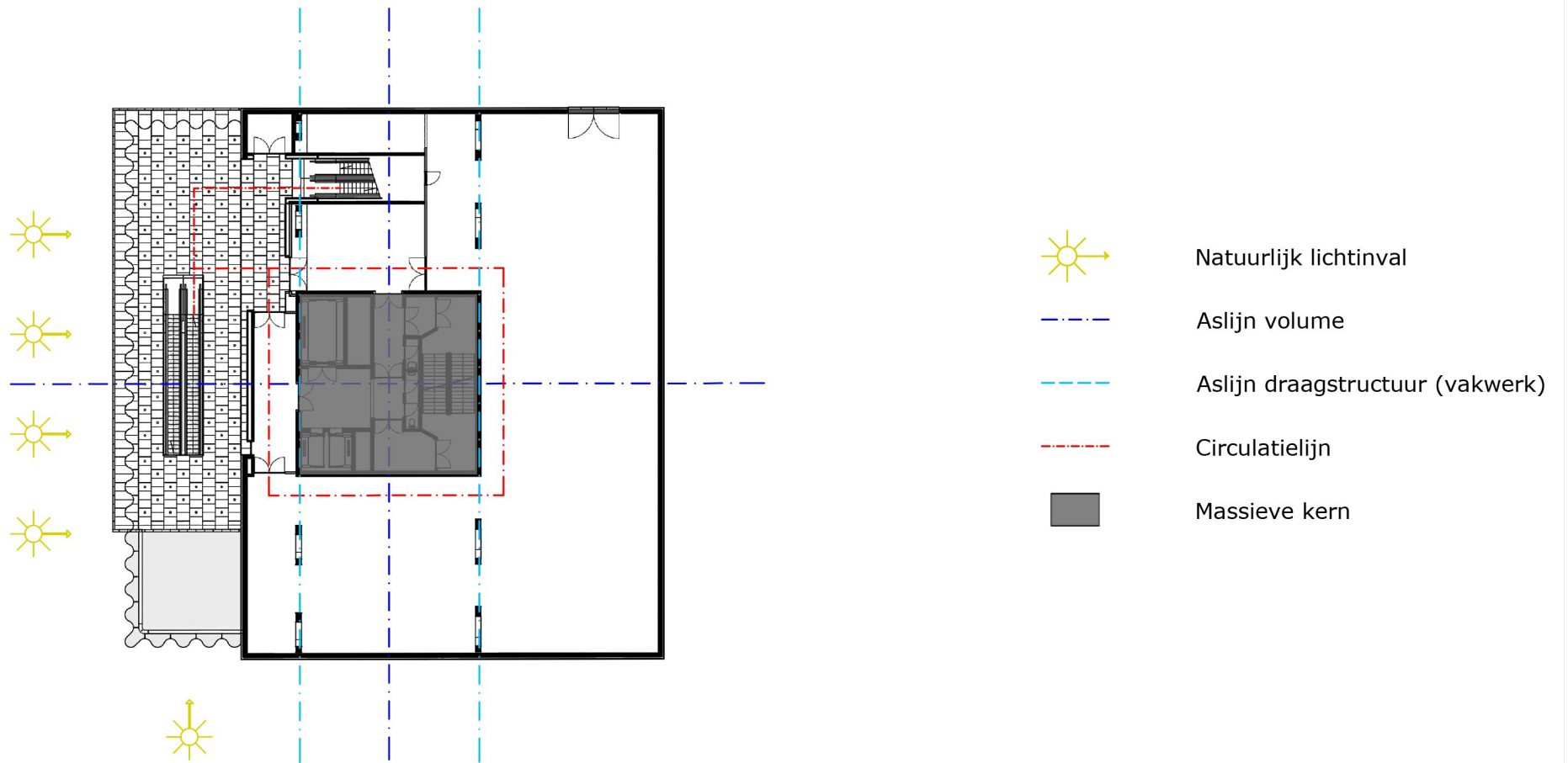

level 06

Plananalyse

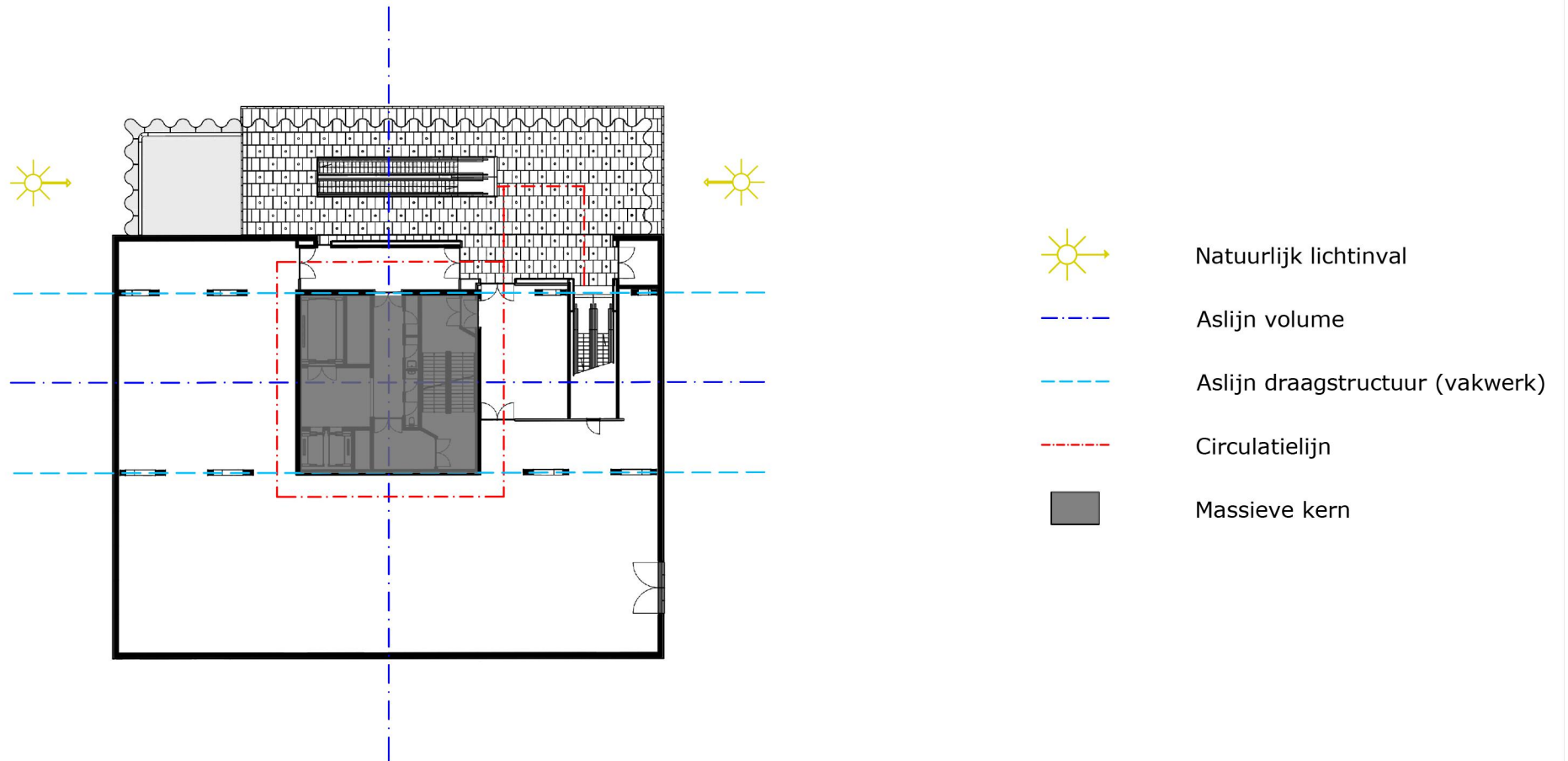

level 07

Plananalyse

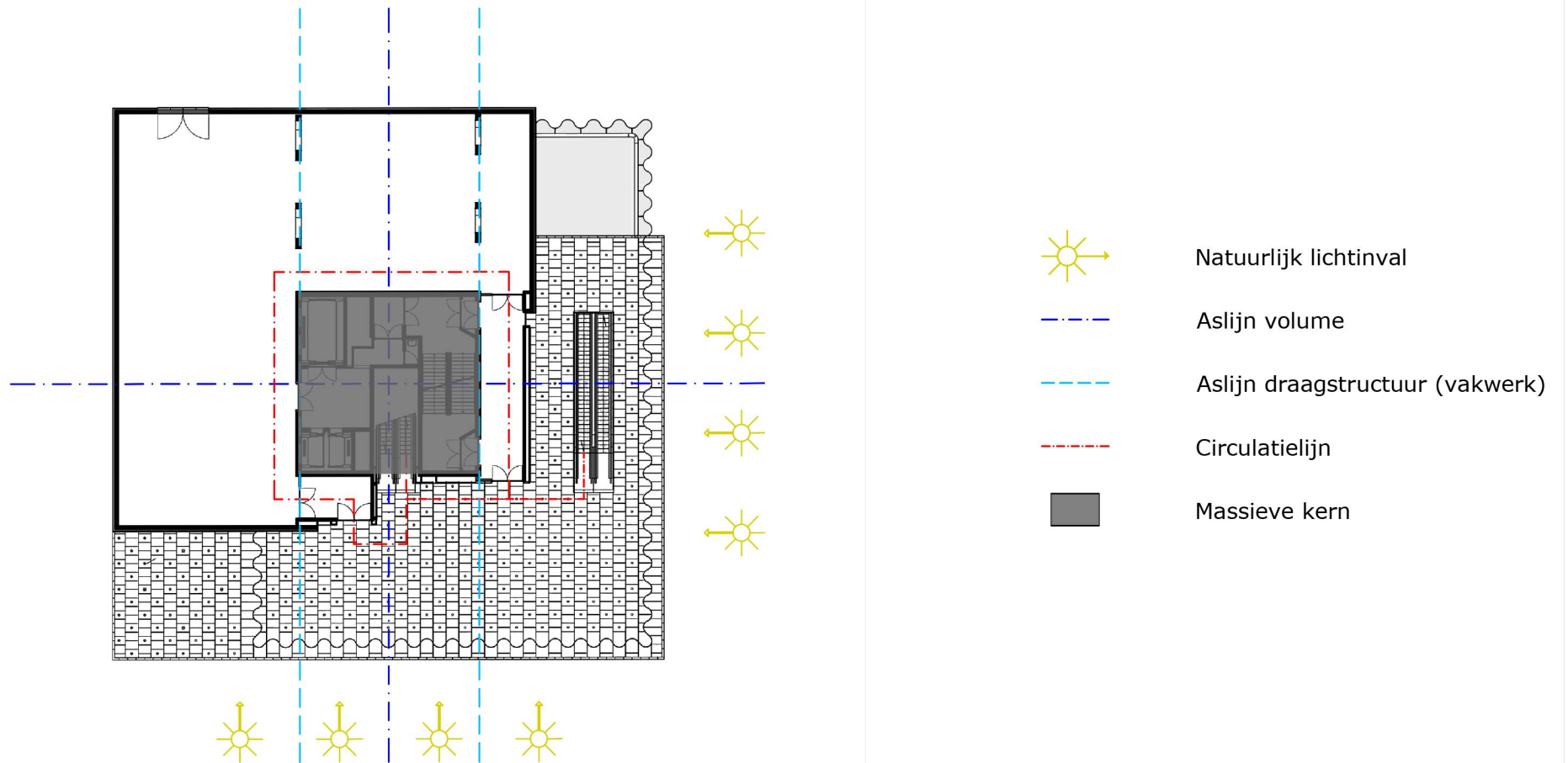

level 08

Plananalyse

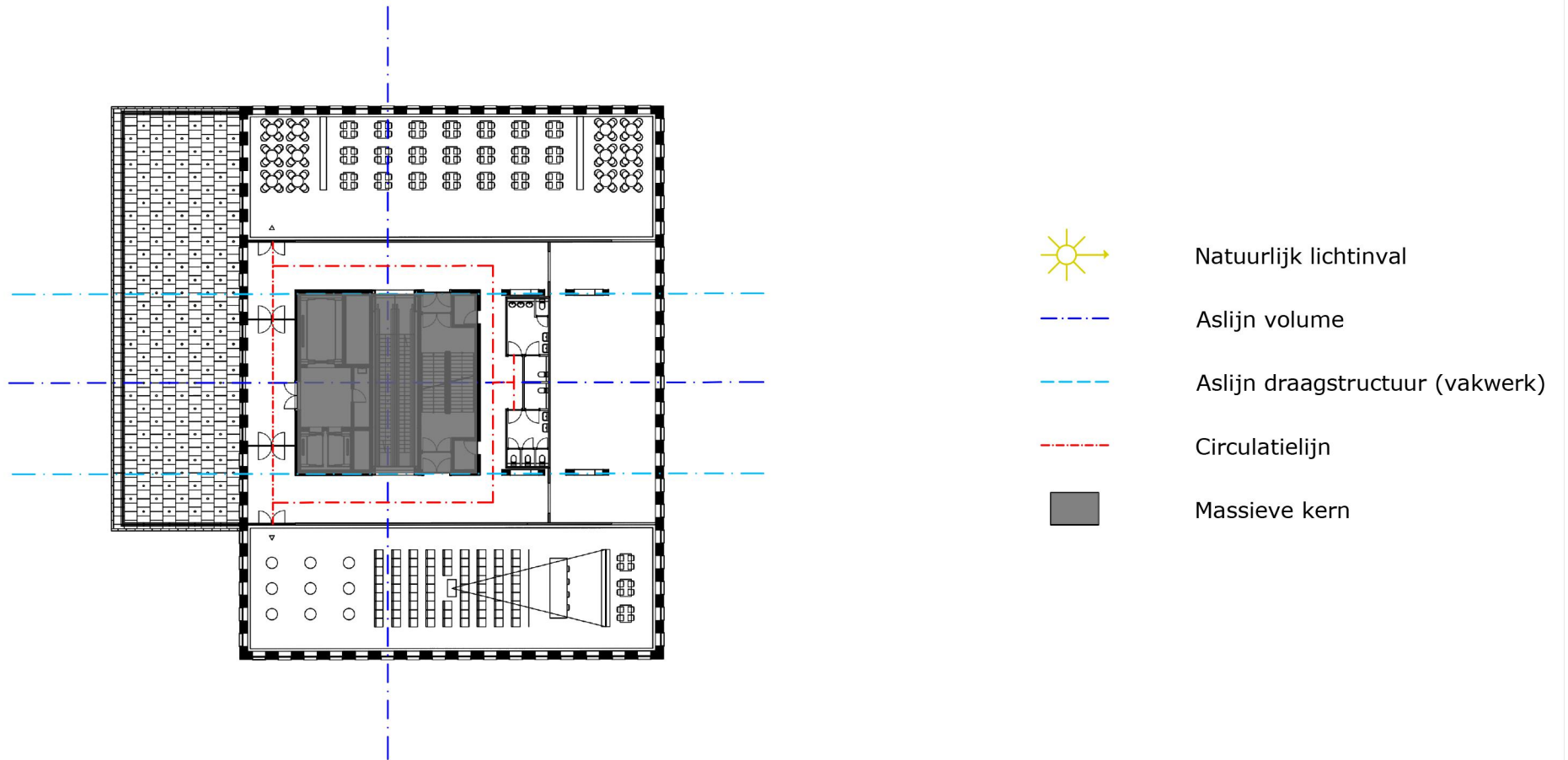

level 09

Snede-analyse

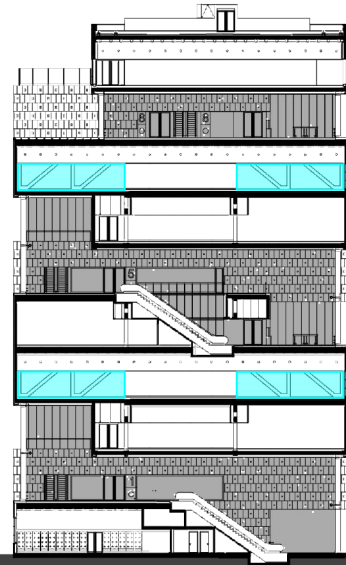

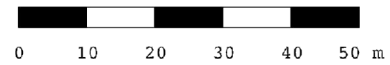

section

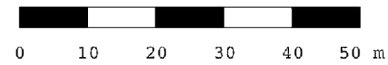

section



-  Vakwerkstructuur
-  Massieve kern

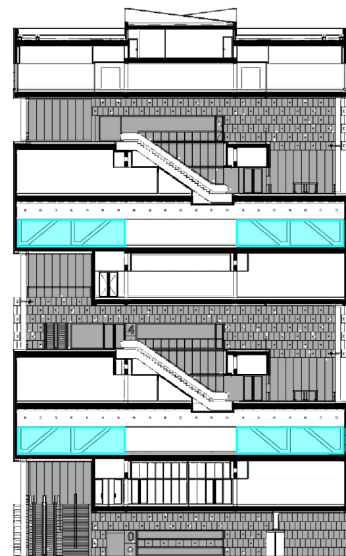

section

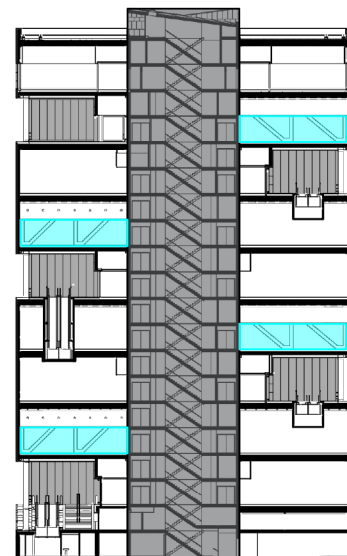
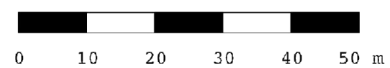

section

